



Sigma 1-16K

Sigma 1-16K IVD

From serial no. 145758



Refrigerated Centrifuge

Operating Manual

Please retain for later use!

© Copyright by
Sigma Laborzentrifugen GmbH
An der Unteren Söse 50
37520 Osterode am Harz
Germany

Tel.: +49 (0) 5522 / 5007-0
Fax: +49 (0) 5522 / 5007-12
Web: www.sigma-zentrifugen.de
E-mail: info@sigma-zentrifugen.de

| | | |
|----------|--|-----------|
| 1 | General information | 9 |
| 1.1 | Importance of the operating manual | 9 |
| 1.2 | Intended use | 9 |
| 1.3 | Warranty and liability | 9 |
| 1.4 | Copyright | 10 |
| 1.5 | Standards and regulations | 10 |
| 1.6 | Scope of supply | 10 |
| 2 | Layout and mode of operation | 11 |
| 2.1 | Layout of the centrifuge | 11 |
| 2.1.1 | Functional and operating elements | 11 |
| 2.1.2 | Name plate | 12 |
| 2.2 | Mode of operation | 13 |
| 2.2.1 | Centrifugation principle | 13 |
| 2.2.2 | Area of application | 13 |
| 2.2.2.1 | Speed, radius, and relative centrifugal force | 14 |
| 2.2.2.2 | Density | 14 |
| 3 | Safety | 15 |
| 3.1 | Marking of the unit | 15 |
| 3.2 | Explanation of the symbols and notes | 16 |
| 3.3 | Responsibility of the operator | 17 |
| 3.4 | Operating personnel | 17 |
| 3.5 | Informal safety instructions | 17 |
| 3.6 | Safety instructions | 18 |
| 3.6.1 | Electrical safety | 18 |
| 3.6.2 | Mechanical safety | 18 |
| 3.6.3 | Fire prevention | 19 |
| 3.6.4 | Chemical and biological safety | 19 |
| 3.6.5 | Safety instructions for centrifugation | 20 |
| 3.6.6 | Resistance of plastics | 20 |
| 3.6.7 | Safety of rotors and accessories | 21 |
| 3.6.7.1 | Service life | 21 |
| 3.7 | Safety devices | 21 |
| 3.7.1 | Lid lock device | 21 |
| 3.7.2 | Standstill monitoring system | 22 |
| 3.7.3 | System check | 22 |
| 3.7.4 | Earth conductor check | 22 |
| 3.7.5 | Temperature monitoring system | 22 |
| 3.8 | Measures in the event of hazards and accidents | 22 |
| 3.9 | Remaining hazards | 22 |

Table of contents

| | | |
|----------|--|-----------|
| 4 | Storage and transport | 23 |
| 4.1 | Dimensions and weight..... | 23 |
| 4.2 | Storage conditions | 23 |
| 4.3 | Notes on transport | 23 |
| 4.4 | Packaging..... | 24 |
| 4.5 | Transport safety device..... | 24 |
| 5 | Set-up and connection | 25 |
| 5.1 | Installation site | 25 |
| 5.2 | Power supply | 25 |
| 5.2.1 | Type of connection | 25 |
| 5.2.2 | Customer-provided fuses..... | 26 |
| 6 | Using the centrifuge | 27 |
| 6.1 | Initial start-up | 27 |
| 6.2 | Switching the centrifuge on | 27 |
| 6.2.1 | Opening and closing the lid..... | 27 |
| 6.2.2 | Installation of rotors and accessories | 28 |
| 6.2.2.1 | Installation of a rotor | 28 |
| 6.2.2.2 | Installation of a microhaematocrit rotor | 29 |
| 6.2.2.3 | Installation of accessories | 30 |
| 6.2.2.4 | Vessels | 30 |
| 6.3 | Control System "Spincontrol Basic" | 31 |
| 6.3.1 | User interface | 31 |
| 6.3.2 | Display..... | 31 |
| 6.3.3 | Starting a centrifugation run..... | 32 |
| 6.3.4 | Interrupting a centrifugation run | 32 |
| 6.3.5 | Interrupting a deceleration process..... | 32 |
| 6.3.6 | Speed / Relative centrifugal force (RCF)..... | 32 |
| 6.3.6.1 | Changing the speed/RCF value during centrifugation | 32 |
| 6.3.7 | Runtime | 33 |
| 6.3.7.1 | Changing the runtime during centrifugation..... | 33 |
| 6.3.7.2 | Short run..... | 33 |
| 6.3.7.3 | Continuous run..... | 34 |
| 6.3.8 | Temperature | 34 |
| 6.3.8.1 | Precooling program "Precool" | 34 |
| 6.3.9 | Softstart and softstop function | 35 |
| 6.3.10 | Rotor selection..... | 36 |
| 6.3.11 | Program..... | 37 |
| 6.3.11.1 | Saving the current settings..... | 37 |
| 6.3.11.2 | Calling up stored programs | 37 |
| 6.4 | Switching the centrifuge off | 37 |

Table of contents

| | | |
|-----------|--|-----------|
| 7 | Malfunctions and error correction | 38 |
| 7.1 | General malfunctions..... | 38 |
| 7.1.1 | Emergency lid release..... | 39 |
| 7.2 | Table of error codes..... | 40 |
| 7.3 | Service contact..... | 41 |
| 8 | Maintenance and service | 42 |
| 8.1 | Maintenance..... | 42 |
| 8.1.1 | Centrifuge..... | 42 |
| 8.1.1.1 | Condenser (only refrigerated centrifuges with an air-cooled refrigeration system) | 43 |
| 8.1.2 | Accessories..... | 43 |
| 8.1.2.1 | Plastic accessories..... | 44 |
| 8.1.3 | Rotors..... | 44 |
| 8.1.4 | Microhaematocrit rotor..... | 44 |
| 8.1.5 | Glass breakage..... | 45 |
| 8.2 | Sterilisation and disinfection of the rotor chamber and accessories..... | 45 |
| 8.2.1 | Autoclaving..... | 46 |
| 8.3 | Service..... | 47 |
| 8.4 | Return of defective centrifuges or parts..... | 48 |
| 9 | Disposal | 50 |
| 9.1 | Disposal of the centrifuge..... | 50 |
| 9.2 | Disposal of the packaging..... | 50 |
| 10 | Technical data | 51 |
| 10.1 | Ambient conditions..... | 53 |
| 10.2 | Technical documentation..... | 53 |
| 11 | Appendix | 54 |
| 11.1 | Range of accessories..... | 54 |
| 11.1.1 | Rotor radii..... | 54 |
| 11.2 | Speed-gravitational-field-diagram..... | 55 |
| 11.3 | Table of the service life of rotors and accessories..... | 56 |
| 11.4 | Resistance data..... | 57 |
| 11.5 | EC declaration of conformity..... | 61 |
| 11.6 | Declaration of conformity – China RoHS 2..... | 65 |
| 12 | Index | 67 |

Table of contents

1 General information

1.1 Importance of the operating manual

A fundamental requirement for the safe and trouble-free operation of the centrifuge is to be familiar with the fundamental safety instructions and all possible hazards.

The operating manual includes important information concerning the safe operation of the centrifuge.

This operating manual and, in particular, the notes on safety and hazards must be observed by all persons operating the centrifuge.

In addition, the local rules and regulations for the prevention of accidents must be complied with.

1.2 Intended use

The laboratory centrifuge is suitable for the separation of constituents of different densities in mixtures with a maximum density of 1.2 g/cm³.

The laboratory centrifuge that is marked with IVD is intended for human biological samples, including donated blood and tissue, in conjunction with diagnostic in-vitro applications. This means that it is a medical product in accordance with the IVD directive 98/79/EC.

Only trained, specialised personnel are authorised to use the centrifuge in closed laboratories.

The intended use also includes:

- observation of all of the notes and instructions that are included in the operating manual and
- compliance with the inspection and maintenance instructions.

Sigma Laborzentrifugen GmbH cannot be held liable for any damage resulting from non-compliance.

1.3 Warranty and liability

The warranty and liability are subject to our "General Conditions" that were distributed to the operator upon the conclusion of the contract.

Warranty and liability claims are excluded if they are due to:

- improper use.
- non-compliance with the safety instructions and hazard warnings in the operating manual.
- improper installation, start-up, operation, or maintenance of the centrifuge.

1 General information

1.4 Copyright

The copyright concerning the operating manual remains with Sigma Laborzentrifugen GmbH.

The operating manual is solely intended for the operator and their personnel. It includes instructions and information that must not be

- duplicated,
- distributed, or
- communicated in any other way.

Non-compliance may be prosecuted under criminal law.

1.5 Standards and regulations

EC declaration of conformity
(see chapter 11.5 - "EC declaration of conformity")

1.6 Scope of supply

The centrifuge comprises:

- 1 power cord with IEC C13 connector
- 1 socket wrench, size 4 (rotor) Part no. 930 050
- 1 socket wrench, size 6 (emergency release) Part no. 930 056

Documentation

Operating manual incl. EC declaration of conformity
(see chapter 11.5 - "EC declaration of conformity")

Accessories

According to your order, our order confirmation, and your delivery note.

2 Layout and mode of operation

2.1 Layout of the centrifuge

2.1.1 Functional and operating elements

- 1 Lid
- 2 Display
- 3 User interface
(see chapter 6.3.1 -
"User interface")



Fig. 1: Total view of the centrifuge

- 4 Mains power switch
- 5 Mains power input
- 6 Name plate
(see chapter 2.1.2 -
"Name plate")



Fig. 2: Rear view of the centrifuge (example)

2 Layout and mode of operation

2.1.2 Name plate

- 1 Manufacturer
- 2 Power consumption
- 3 Max. speed
- 4 Max. kinetic energy
- 5 Serial number
- 6 Part number
- 7 Type
- 8 Nominal voltage
- 9 CE mark in compliance with the directive 2006/42/EC
- 10 Symbol for special disposal (see chapter 9 - "Disposal")
- 11 Consult operating manual
- 12 Date of manufacture
- 13 IVD mark (if applicable)
- 14 Max. permissible density
- 15 Refrigerant data

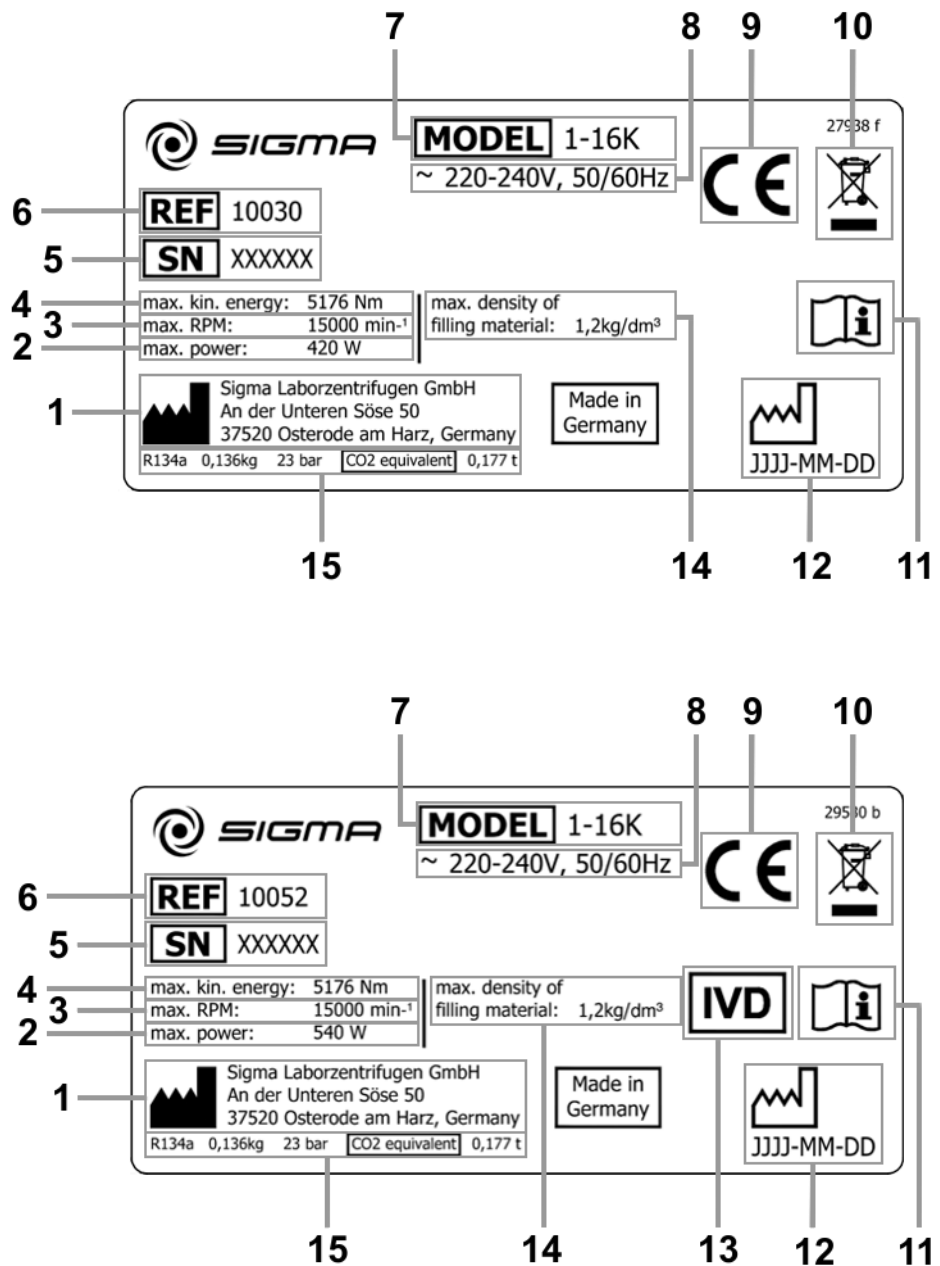

Fig. 3: Examples of name plates

2.2 Mode of operation

2.2.1 Centrifugation principle

Centrifugation is a process for the separation of heterogeneous mixtures of substances (suspensions, emulsions, or gas mixtures) into their components. The mixture of substances, which rotates on a circular path, is subject to centripetal acceleration that is several times greater than the gravitational acceleration.

Centrifuges use the mass inertia inside the rotor chamber for separating the substances. Due to their higher inertia, particles or media with a higher density travel outwards. In doing so, they displace the components with a lower density, which in turn travel towards the centre.

The centripetal acceleration of an object inside a centrifuge, as the effect of centripetal force, depends on the distance between the object and the axis of rotation as well as on the angular velocity. It increases linearly as a function of the distance with regard to the axis of rotation and quadratically as a function of the angular velocity. The bigger the radius in the rotor chamber is and the higher the speed is, the higher the centripetal acceleration is. However, the forces acting on the rotor also increase.

2.2.2 Area of application

Depending on the area of application of the centrifuge and also on the particle size, solids content, and volume throughput of the mixture of substances that is to be centrifuged, there are different types of centrifuges.

The areas of application go from household use as a salad spinner or honey separator up to specialised technical applications in the clinical, biological, or biochemical context:

- For numerous clinical examinations, cellular material must be separated from the liquid to be analysed. The normal separation process can be sped up considerably by using laboratory centrifuges.
- In the metal-working industry, centrifuges are used for separating oil from metal cuttings. Dairies use centrifuges in order to separate cow's milk into cream and low-fat milk.
- Particularly big centrifuges are used in the sugar industry for separating the syrup from the crystalline sugar.
- Ultracentrifuges are predominantly used in biology and biochemistry in order to isolate particles, e.g. viruses. They are specifically designed for high speeds up to 500,000 rpm. The rotor moves in a vacuum in order to avoid air friction.

2 Layout and mode of operation

2.2.2.1 Speed, radius, and relative centrifugal force

The acceleration g , which the samples are subject to, can be increased by increasing the radius in the rotor chamber and by increasing the speed. These three parameters are interdependent and linked with each other via the following formula:

$$\text{Relative centrifugal force RCF} = 11.18 \times 10^{-6} \times r \times n^2$$

r = radius in cm

n = speed in rpm

RCF without any dimension

If two values are entered, the third value is determined by way of the stated formula. If, afterwards, the speed or the radius is changed, the resulting relative centrifugal force will be recalculated automatically by the control unit. If the RCF is changed, the speed will be adapted while the specified radius is maintained.

The speed-gravitational-field-diagram provides an overview of the relationship between speed, radius, and RCF (see chapter 11.2 - "Speed-gravitational-field-diagram").

2.2.2.2 Density

The laboratory centrifuge is suitable for the separation of constituents of different densities in mixtures with a maximum density of 1.2 g/cm^3 . All information concerning the speed of rotors and accessories refers to liquids with a density corresponding to this specification. If the density is above this value, the maximum permissible speed of the centrifuge must be reduced based on the following formula:















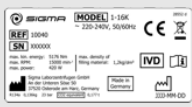



$$n = n_{max} \times \sqrt{(1,2 / Rho)}$$

Rho = density in g/cm^3

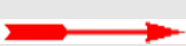
3 Safety

3.1 Marking of the unit

The following symbols are used for all types of centrifuges manufactured by Sigma:

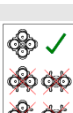
| | | | |
|---|---|---|--|
|  | Dangerous voltage |  | On (Power) |
|  | Hot surface |  | Off (Power) |
|  | Caution! Risk of bruising |  | Name plate (see chapter 2.1.2 - "Name plate") |
|  | Protective earth (ground) |  | CE mark in compliance with the directive 2006/42/EC |
|  | Earth (ground) |  | Do not dispose as part of domestic waste |
|  | Unplug the mains plug |  | Do not dispose as part of domestic waste |
|  | g-lock® system installed |  | GS mark (tested safety; only for Germany) |
|  | Arrow indicating the direction of rotation |  | NRTL mark (only for the USA and Canada) |
|  | 4°C Guarantee |  | RCM mark (only for Australia) |
|  | Centrifuge with heating system |  | Medical product in accordance with the IVD directive 98/79/EC (In-vitro diagnostica) |
|  | Rotor loading information (see chapter 6.2.2.3 - "Installation of accessories") | | |

3 Safety



Safety indications on the centrifuge must be kept readable at all times. If necessary, they must be replaced.



Not all of the symbols/labels are used for this centrifuge type.

3.2 Explanation of the symbols and notes

In this operating manual, the following names and symbols to indicate hazards are used:



This symbol stands for a **direct** hazard to the life and health of persons.

Non-observance of these symbols **causes** serious health problems up to life-endangering injuries.



This symbol stands for a **direct** hazard to the life and health of persons due to electrical voltage.

Non-observance of these symbols **causes** serious health problems up to life-endangering injuries.



This symbol stands for a **potential** hazard to the life and health of persons.

Non-observance of these symbols **can** cause serious health problems up to life-endangering injuries.



This symbol indicates a potentially hazardous situation

Non-observance of these notes can cause minor injuries or damage to property.



This symbol indicates important information.

3.3 Responsibility of the operator

The operator undertakes to authorise only trained, specialised personnel to work on the centrifuge (see chapter 3.4 - "Operating personnel").

The areas of responsibility of the personnel concerning the operation, maintenance, and care of the unit must be clearly defined.

The safety-conscious work of the personnel in compliance with the operating manual and the relevant EC health and safety directives, and the national laws concerning health and safety and the prevention of accidents must be checked at regular intervals (e.g. every month).

Under the international rules for health and safety at work, the operator is obliged to:

- take measures in order to prevent danger to life or health during work.
- ensure that the centrifuges are used properly and entirely as intended (see chapter 1.2 - "Intended use").
- take protective measures against fire and explosion when working with hazardous substances.
- take measures for the safe opening of the centrifuges.

The operator must perform a risk assessment concerning potential accidents in connection with the centrifuge and take design-related countermeasures, if necessary.

The centrifuge has to be maintained regularly (see chapter 8 - "Maintenance and service").

Components that are not in a perfect state must be replaced immediately.

3.4 Operating personnel

Only trained, specialised personnel are authorised to operate the unit. The persons operating the unit must

- be familiar with the fundamental health, safety, and accident prevention regulations.
- have read and understood this operating manual, in particular the safety sections and warning notes, and confirmed this with their signature.

3.5 Informal safety instructions

- This operating manual is a part of the product.
- The operating manual must be kept at the location of use of the centrifuge. Ensure that it is accessible at all times.
- The operating manual must be handed over to any subsequent owner or operator of the centrifuge.
- Any changes, additions or updates received must be added to the operating manual.
- In addition to the operating manual, the general and local rules and regulations concerning the prevention of accidents and the protection of the environment must also be supplied.
- Safety and danger indications on the centrifuge must be kept readable at all times. If necessary, they must be replaced.

3 Safety

3.6 Safety instructions

3.6.1 Electrical safety

To reduce the risk of electrical shock, the centrifuge uses a three-wire electrical cord and plug to connect the equipment to earth-ground. To preserve this safety feature:



DANGER

- Ensure that the wall socket is properly wired and grounded.
- Check that the mains voltage agrees with the nominal voltage listed on the name plate.
- Do not place vessels containing liquid on the centrifuge lid or within the safety distance of 30 cm around the centrifuge. Spilled liquids may get into the centrifuge and damage electrical or mechanical components.
- Only qualified and specialised personnel are authorised to perform service tasks or repairs of the electrical system for which the housing needs to be removed.
- Inspect the electrical equipment of the unit regularly. Defects such as loose or burnt cables must be eliminated immediately.
- Following the completion of any type of repair or service, the qualified and specialised personnel must perform final inspection and testing in compliance with the relevant standards.

3.6.2 Mechanical safety

In order to ensure the safe operation of the centrifuge, observe the following:



WARNING

- Do not open the lid when the rotor is in motion!
- Do not reach into the rotor chamber when the rotor is in motion!
- Do not use the centrifuge if it was installed incorrectly.
- Do not use the centrifuge without panels.
- Do not use the centrifuge if the rotors and inserts show signs of corrosion or other defects.
- Never operate the instrument without a rotor installed.
- Only use the centrifuge with rotors and accessories that have been approved by the manufacturer. In case of doubt, contact the manufacturer (see chapter 7.3 - "Service contact").
- Do not hold your fingers between the lid and the housing when closing the lid. Risk of crushing!
- Defective lid relieving devices could cause the centrifuge lid to fall (contact the service department, if necessary). Risk of crushing!
- Do not hit or move the centrifuge during its operation.
- Do not lean against or rest on the centrifuge during its operation.
- Do not spin any substances that could damage the material of the rotors and buckets of the centrifuge in any way. Highly corrosive substances, for example, damage the material and affect the mechanical strength of the rotors and buckets.

**WARNING**

- Stop the centrifuge immediately in the event of a malfunction. Eliminate the malfunction (see chapter 7 - "Malfunctions and error correction") or inform the service department of Sigma Laborzentrifugen GmbH (see chapter 7.3 - "Service contact").
- If the housing becomes damaged, do not use the centrifuge. Contact the service department of Sigma Laborzentrifugen GmbH (see chapter 7.3 - "Service contact").
- Ensure that all repairs are performed only by authorised and specialised personnel.
- Prior to any start-up, check the centrifuge, rotor, and accessories for signs of damage that can be discerned from the outside. Special attention must be paid to all of the rubber parts (e.g. motor cover, lid seal, and adapters) in terms of visible structural changes. Defective parts must be replaced immediately.
- Open the centrifuge when it is not in use so that moisture can evaporate.

3.6.3 Fire prevention

**DANGER**

- Do not spin explosive or inflammable substances.
- Do not use the centrifuge within hazardous locations.

3.6.4 Chemical and biological safety

If pathogenic, toxic, or radioactive samples are intended to be used in the centrifuge, it is in the responsibility of the user to ensure that all necessary safety regulations, guidelines, precautions, and practices are adhered to accordingly.

**DANGER**

- Infectious, toxic, pathogenic, and radioactive substances may only be used in special, certified containment systems with a bio-seal in order to prevent the material from being released.
- Take suitable precautions for your own safety if there is a risk of toxic, radioactive, or pathogenic contamination
- Materials that chemically react with each other with a high level of energy are prohibited.

**WARNING**

- Keep informed about local measures to avoid harmful emissions (depending on the substances to be centrifuged).
- Protective clothing is not required for the operation of the centrifuge. The materials to be centrifuged may, however, require special safety measures (e.g. centrifugation of infectious, toxic, radioactive, or pathogenic substances).

3 Safety

3.6.5 Safety instructions for centrifugation

For safe operation, observe the following before starting the centrifuge:



WARNING

- Ensure that the centrifuge was set up properly (see chapter 5 - "Set-up and connection").
- Maintain a safety distance of at least 30 cm (12 inches) around the centrifuge.
- Do not store any dangerous goods in the centrifuge area.
- Do not stay in the safety area longer than what is absolutely necessary for the operation of the centrifuge.
- Only use the centrifuge with rotors and accessories that have been approved by the manufacturer. We explicitly warn against the use of equipment of poor quality. Breaking glass or bursting vessels can cause dangerous imbalances at high speeds
- Ensure that rotor and buckets are correctly fitted (see chapter 6.2.2.1 - "Installation of a rotor").
- Observe the instructions on the installation of accessories (see chapter 6.2.2.3 - "Installation of accessories").
- The rotor must be loaded in a rotationally symmetrical manner at equal weights.
- If liquids with a density $> 1.2 \text{ g/cm}^3$ are used, reduce the speed (see chapter 2.2.2.2 - "Density").
- Do not use the centrifuge if the rotor is loaded asymmetrically.
- Do not use the centrifuge with tubes that are excessively long.



WARNING

3.6.6 Resistance of plastics

Chemical influences have a strong effect on the polymeric chains of plastics, and, therefore, on their physical properties. Plastic parts can be damaged if solvents, acids, or alkaline solutions are used.



NOTE

- Refer to the resistance data (see chapter 11.4 - "Resistance data")!

3.6.7 Safety of rotors and accessories

3.6.7.1 Service life

The rotors and accessories have a limited service life.



WARNING

- Perform regular checks (at least once per month) for safety reasons!
- Pay special attention to changes, such as corrosion, cracks, material abrasion, etc.
- After 10 years, they must be inspected by the manufacturer.
- After 50,000 cycles, the rotor must be scrapped for reasons of safety.
- If other data concerning the service life are engraved on the rotor or bucket, these data shall apply accordingly. For example, a bucket with the engraving "max. cycles = 10,000" has a service life of 10,000 cycles, and a rotor with the engraving "Exp. date 01/27" must be scrapped in January 2027 at the latest (see figure).
- If a specification concerning the maximum number of cycles **and** a specification concerning the service life (i.e. a date) are provided, the specification that occurs first shall apply.

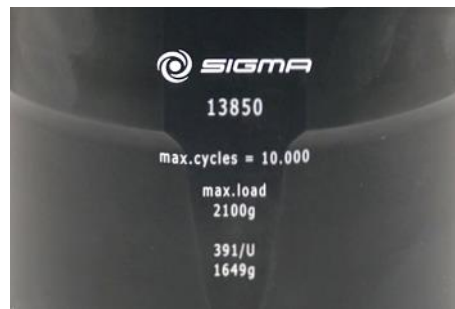

Fig. 4: Different service life – engraving on the bucket/rotor



NOTE

- Refer to the table of rotors and accessories with a different service life (see chapter 11.3 - "Table of the service life of rotors and accessories")!

3.7 Safety devices

3.7.1 Lid lock device

The centrifuge can only be started when the lid is properly closed. The electrical lock must be locked. The lid can only be opened when the rotor has stopped. If the lid is opened by way of the emergency release system during operation, the centrifuge will immediately switch off and decelerate brakeless. If the lid is open, the drive is completely separated from the mains power supply, i.e. the centrifuge cannot be started (see chapter 7.1.1 - "Emergency lid release").

3 Safety

3.7.2 Standstill monitoring system

Opening of the centrifuge lid is only possible if the rotor is at a standstill. This standstill is checked by the microprocessor.

3.7.3 System check

An internal system check monitors the data transfer and sensor signals with regard to plausibility. The system continuously performs a self-check and identifies malfunctions. Malfunctions are indicated by error messages with a number in the speed/rcf display (see chapter 7.2 - "Table of error codes").

3.7.4 Earth conductor check

An earth conductor check can be carried out by authorised and specialised personnel using a suitable measuring instrument. Please contact the Sigma service department (see chapter 7.3 - "Service contact").

3.7.5 Temperature monitoring system

If the temperature inside the rotor chamber rises above 50°C, the drive system will be switched off automatically. The centrifuge cannot be restarted until it has cooled.

3.8 Measures in the event of hazards and accidents



DANGER

- If an emergency arises, switch off the centrifuge immediately!
- If in doubt, call the emergency doctor!

3.9 Remaining hazards

The centrifuge was built in accordance with the state of the art and in compliance with the generally recognized safety rules. However, danger to life and limb of the operator, or of third parties, or impairments of the unit or other material assets cannot be completely excluded when the unit is being used.

- Use the unit only for the purpose that it was originally intended for (see chapter 1.2 - "Intended use").
- Use the unit only if it is in a perfect running state.
- Immediately eliminate any problems that can affect safety.

4 Storage and transport

4.1 Dimensions and weight

| | 1-16K, 1-16K IVD |
|-----------------------|------------------|
| Height: | 291 mm |
| Height with open lid: | 547 mm |
| Width: | 310 mm |
| Depth: | 660 mm |
| Weight: | 34 kg |

4.2 Storage conditions

The centrifuge can be stored in its original packaging for up to a year.

- Store the centrifuge only in dry rooms.
- The permissible storage temperature is between -20°C and +60°C.
- If you would like to store it for more than one year, or if you intend to ship it overseas, please contact the manufacturer.

4.3 Notes on transport

- When lifting the centrifuge, always reach under the centrifuge from the side.



CAUTION

The centrifuge weighs approx. 34 kg!

- For transport use suitable packaging and, if at all possible, the original packaging (see chapter 4.4 - "Packaging").

4 Storage and transport

4.4 Packaging

The centrifuge is packaged in a cardboard box.

- Open the box.
- Take out the box containing the accessories.
- Lift the centrifuge with both foam cushions out of the cardboard box.
When lifting the centrifuge, always reach under the centrifuge from the side.



CAUTION

The centrifuge weighs approx. 34 kg!

- Retain the packaging for any possible future transport of the centrifuge.

4.5 Transport safety device

The centrifuge is not equipped with a transport safety device.

5 Set-up and connection

5.1 Installation site

Operate the centrifuge only in closed and dry rooms.

All the energy supplied to the centrifuge is converted into heat and emitted to the ambient air.

- Ensure sufficient ventilation.
- Keep a safety distance of at least 30 cm around the centrifuge so that the vents in the centrifuge remain fully effective.
- Do not subject the centrifuge to thermal stress, e.g. by positioning it near heat generators.
- Avoid direct sunlight (UV radiation).
- The table must be stable and have a solid, even surface.
- Attention: During transport from cold to warmer places, condensational water will collect inside the centrifuge. It is important to allow sufficient time for drying (min. 24 h) before the centrifuge can be used again.

5.2 Power supply

5.2.1 Type of connection



DANGER

The operating voltage on the name plate must correspond to the local supply voltage!



CAUTION

The mains power plug is an isolating device which is why it must be accessible at all times.

Sigma centrifuges are units of protection class I. The centrifuges of this model series have a three-wire power cord with an IEC C13 connector.



NOTE

The removable power cord must not be longer than 3 m!
The power cord must not be replaced with a power cord of inadequate rating!

5 Set-up and connection

5.2.2 Customer-provided fuses

Typically, the centrifuge must be protected with 16 Amp L or B fuses that are to be provided by the customer.



To ensure safe disconnection in the event of a fault, an AC/DC-sensitive RCD (residual current device) must be integrated in the wiring system of the building.

6 Using the centrifuge

6.1 Initial start-up



DANGER

- Before the initial start-up, please ensure that your centrifuge is properly set up and installed (see chapter 5 - "Set-up and connection").

6.2 Switching the centrifuge on

- Press the mains power switch.
The display then illuminates. The centrifuge is ready for operation.

6.2.1 Opening and closing the lid

The lid can be opened if the centrifuge is at a standstill.

- Press the lid key in order to open the lid.

The centrifuge cannot be started if the lid is opened.

- To close, press with both hands slightly on the lid until the lid lock is locked.



WARNING

Do not place your fingers between the lid and the housing when closing the lid. Risk of crushing!

6 Using the centrifuge

6.2.2 Installation of rotors and accessories

6.2.2.1 Installation of a rotor

- Open the centrifuge lid by pressing the lid key.
- Loosen the rotor tie-down screw by turning it anti-clockwise, but do not remove it.
- Lower the rotor with its central bore straight down onto the motor shaft.
- Tighten the rotor tie-down screw clockwise with the supplied rotor wrench with 3 Nm. In doing so, hold the rotor at its outer rim.
- Follow the safety instructions and hazard warnings (see chapter 3 - "Safety")!



WARNING

Once a day or after 20 cycles, the rotor tie-down screw must be loosened by some turns, and the rotor must be lifted and fastened again. This ensures a proper connection between the rotor and the motor shaft.



NOTE

Rotors can be used without a cover. This leads, however, to higher levels of noise and temperatures when running.

Removal of a rotor

- Loosen the rotor tie-down screw by turning it anti-clockwise and remove the rotor.

6.2.2.2 Installation of a microhaematocrit rotor

Fig. 5: Microhaematokrit rotor (part no. 11024) with reader (part no. 17029)

- Open the centrifuge lid by pressing the lid key.
- Loosen the rotor tie-down screw by turning it anti-clockwise, but do not remove it.
- Lower the rotor with its central bore straight down onto the motor shaft.
- Tighten the rotor tie-down screw clockwise with 3 Nm using the supplied rotor wrench. In doing so, hold the microhaematocrit rotor with one hand and tilt it slightly in order to prevent the motor shaft from slipping through.
- Follow the safety instructions and hazard warnings (see chapter 3 - "Safety")!

Operation

- Fill the capillary tubes with blood and seal them at one end with putty or by fusion.
- Place the capillary tubes into the recesses of the rotor with the sealed end against the rubber ring. Ensure that the capillary tubes fit tightly against the rubber ring. The opposite places must be loaded.
- Put the rotor cover on and lock it.
- Close the centrifuge lid.
- Enter the following parameters: speed 14,000 rpm, gravitational field RCF max. 18,626 x g, time approx. 5 min.
- Start the centrifuge.
- Open the centrifuge lid when the rotor has stopped.
- Unlock the rotor cover and lift it off.

Evaluation

- Put the reader onto the rotor.
- Turn the reader and perform a fine adjustment with the aid of the central eccentric mechanism in order to localize the O-point and the maximum liquid point in the capillary tubes. You can now read the percentage value.
- Remove the capillary tubes. Some of the tubes can also be evaluated with the reader outside of the rotor (see the instructions for use on the back of the reader).

6 Using the centrifuge

6.2.2.3 Installation of accessories

- Only use tubes that are suitable for the rotor.
- Always load the axial symmetrical inserts of the rotors with the same accessories and fill to avoid imbalance.

Centrifugation with low capacity

- Install the tubes axial symmetrically so that the rotor is loaded evenly.
- It is not permissible to load angle rotors on only one axis.

correct

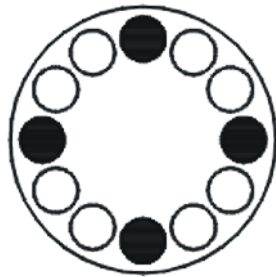

incorrect

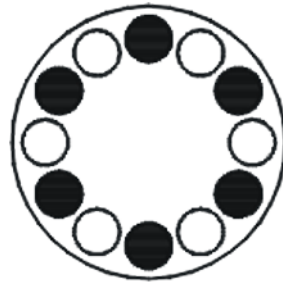
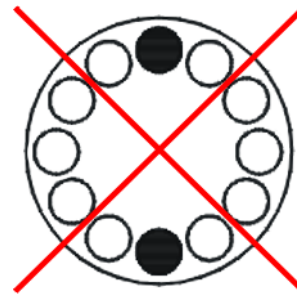

Fig. 6: Permissible and impermissible loading of an angle rotor (example illustration)

6.2.2.4 Vessels

- Load the vessels outside of the centrifuge. Liquids in the bores of the rotor cause corrosion.
- Fill the vessels carefully and arrange them according to their weight. Imbalances result in the excessive wear of the bearings.
- Follow the safety instructions and hazard warnings (see chapter 3 - "Safety")!

6.3 Control System "Spincontrol Basic"

6.3.1 User interface

- 1 Display
- 2 Set key
- 3 Program key
- 4 Arrow keys
- 5 Lid key
- 6 Start/Stop key
- 7 Precool key



Fig. 7: User interface

The centrifuge is started directly via the user interface. When the centrifuge is switched on, all segments will be illuminated for a short time. It is now ready for operation.

6.3.2 Display

The centrifuge display has the following display fields:

- 1 Field for deceleration curves, run mode, and programs
- 2 Speed / RCF field
- 3 Time field
- 4 Field for temperature and rotor selection

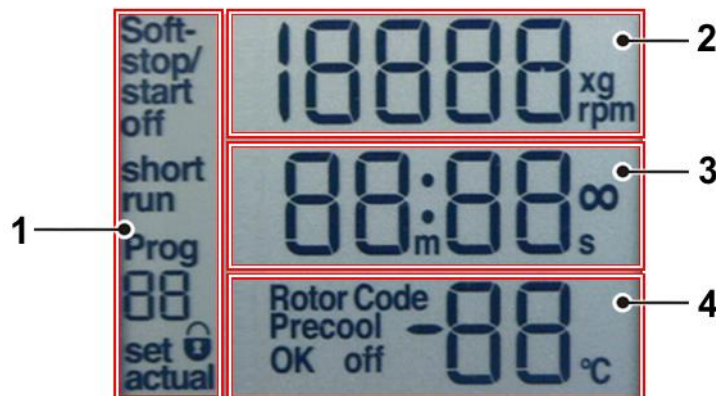

Fig. 8: Display, completely illuminated

6 Using the centrifuge

6.3.3 Starting a centrifugation run

The centrifuge is ready for operation when the mains power switch is on and the lid is closed.

- Press the start/stop key in order to start a centrifugation run.

6.3.4 Interrupting a centrifugation run

- Press the start/stop key in order to interrupt a centrifugation run. The centrifugation run will be terminated prematurely.

6.3.5 Interrupting a deceleration process

- Press the start/stop key during a deceleration process in order to interrupt it and to restart the centrifuge.

6.3.6 Speed / Relative centrifugal force (RCF)

The RCF value is determined by the rotor geometry and speed. The RCF and speed values, therefore, depend on each other. If one of the two values is entered, the other value will be set automatically.

- To preselect a speed value or a RCF value, press the set key repeatedly until the corresponding unit flashes on the display.
- Select the desired speed or RCF value via the arrow keys.
- Confirm the selection by pressing the start/stop key.

The data will also be accepted and saved after approx. 20 seconds if no other key is pressed within this time period.

During operation, you can switch from the speed value to the RCF value and vice versa via the arrow keys.

6.3.6.1 Changing the speed/RCF value during centrifugation

The preselected speed or RCF value can be changed during centrifugation.

- Press the set key repeatedly until the desired unit flashes on the display.
- Change the speed or RCF value by pressing the arrow keys. The parameters will take effect immediately.

6.3.7 Runtime

The preselected total runtime is displayed in the lower line of the display. During centrifugation, the remaining runtime is displayed. The runtime of the centrifuge can be set at one-second-intervals up to 99 minutes and 59 seconds.

- To select a runtime, press the set key repeatedly until the time unit flashes on the display.
- Select the desired runtime by pressing the arrow keys.
- Confirm the selection by pressing the start/stop key.

The data will also be accepted and saved after approx. 20 seconds if no other key is pressed within this time period.

6.3.7.1 Changing the runtime during centrifugation

The preselected runtime can be changed during centrifugation.

- Press the "set" key repeatedly until the time unit flashes on the display.
- Change the desired runtime by pressing the arrow keys. The parameters will be accepted immediately.



If the centrifugation time is changed during the run, the centrifuge will run for the entire new time and will disregard the previous runtime that has already elapsed.

6.3.7.2 Short run

During the short run, the centrifuge accelerates at maximum power until the maximum speed is reached.

- Keep the quick run key pressed during the short run.

The message "short run" and the duration of the short run are displayed.

When the quick run key is released, the centrifuge decelerates at maximum power to a standstill.

After the short run, the lid unlocks automatically and the program that was set beforehand is displayed again.

6 Using the centrifuge

6.3.7.3 Continuous run

During the continuous run, the runtime of the centrifuge is unlimited and must be stopped manually. The centrifuge accelerates during the continuous run until the set speed is reached.

- To start the continuous run, press the set key until the time unit flashes on the display.
- Press the down-key (arrow key) until the display switches from "00:10" to "--:--".

After 99 min 59 sec, any additional runtime will no longer be displayed, but the centrifugation will continue.

- To stop a continuous run, press the start/stop key. The centrifugation will end.
- Enter a runtime. The centrifugation will end after this time.

6.3.8 Temperature

The temperature in the rotor chamber is displayed in the lower third of the centrifuge display. The display alternates between the preselected temperature and the actual temperature. The actual temperature is marked by the word "actual" in front of the temperature value.

Temperatures between -10 °C and + 40 °C can be selected.

- Press the set key until the temperature unit flashes on the display.
- Select the desired temperature by pressing the arrow keys.
- Confirm the selection by pressing the start/stop key.

The data will also be accepted and saved after approx. 20 seconds if no other key is pressed within this time period.

6.3.8.1 Precooling program "Precool"

Depending on the substances to be centrifuged, it may make sense to precool the centrifuge. The precooling prevents the cooled samples in the uncooled centrifuge from heating up to an inadmissible temperature.

Precooling at a standstill may distort the measurement results and subsequently cause increased wear of the mechanical components. This is why the centrifuge has a special program that precools the centrifuge under defined conditions:

- Press the precool key to load the precooling program. The display shows $\frac{1}{3}$ of the maximum rotor speed and the corresponding RCF value, the runtime field indicates "∞" (continuous run). If the set temperature is above the actual temperature, it is limited to the actual temperature.



Once the precooling program is loaded, the set temperature can only be set to values below the actual temperature. If the limits of the setting range are reached during the setting process, the temperature display flashes for approximately 1 second.

- Press the start key to start the precooling program.

Once the set value is reached and remains stable for one minute, the program ends with the indication "Precool OK".

- Press the precool key to terminate the precooling program prematurely. In this case, the indication "Precool off" flashes on the display.

If the precooling program is selected and then deselected without actually being started, the set temperature will be reset to the old value. If, however, the precooling run is started, the limited set temperature will also be used for the following runs, but it will not be saved in the program.

6.3.9 Softstart and softstop function

The softstart function is used to extend the acceleration time, whereas the softstop function is used to extend the deceleration time. The current combination is shown on the display.

- To activate the softstart and softstop functions, press the set key repeatedly until "Soft-stop/start" flashes in the upper left part of the display.
- Press the arrow keys until "Soft-stop/start on" is displayed. The softstart and softstop functions are now activated.
- Press the arrow key until "Soft stop on" is displayed. Only the softstop function will be active and the centrifuge will start at normal speed.
- Press the arrow key until "Soft off" is displayed. The softstart and softstop functions are now deactivated.

The data will be accepted immediately and saved after approx. 20 seconds. You can also change the settings as described above during a centrifugation run.

6 Using the centrifuge

6.3.10 Rotor selection

In the delivery status of the centrifuge, the rotor 12134 is preselected. If another rotor is installed the configuration must be changed, so that the allowed maximum speed of the rotor can be reached.

- To select another rotor, press the set key and hold it for approx. 2 seconds.
- Choose the number of the installed rotor out of the following list, by pressing the arrow keys:

| | | | | | |
|--------------|-------|----------------|-------|-------|-------|
| Code | 1 | 2 | 3 | 4 | 5 |
| Rotor | 11024 | 12024 12120 | 12134 | 12135 | 12136 |
| Code | 6 | 7 | 8 | 9 | 10 |
| Rotor | 12137 | 12180 | 12118 | -- | -- |

- Press the set key to confirm the input.
The RCF value will be adjusted automatically to the selected rotor.



The rotor selection will be saved under the corresponding program number.

6.3.11 Program

The program is used to save or load certain recurrent settings of the centrifuge. 10 different programs can be saved and called up. The precooling program "Precool" does not occupy any storage location and cannot be deleted. It is used to cool the centrifuge without vessels (see chapter 6.3.8.1 - "Precooling program "Precool"").

6.3.11.1 Saving the current settings

- Press the program key. Then, select a program number by pressing the arrow keys. The display "Prog - - " will now flash.
- Select the correct rotor.
- Press the set key repeatedly until the corresponding unit flashes on the display. Select the desired parameters.
- In order to save the data, start the centrifuge or press the set key repeatedly until the indication "Prog - -" stops flashing.



Program numbers that are already occupied will be overwritten with the current data.

6.3.11.2 Calling up stored programs

- Press the program key. Then, select a program number by pressing the arrow keys. The display "Prog - - " will now flash.
- Ensure that the correct rotor is installed.
- In order to save the data, start the centrifuge or press the set key repeatedly until the indication "Prog - -" stops flashing.

6.4 Switching the centrifuge off

- Open the centrifuge when it is not in use so that moisture can evaporate.
- Switch the centrifuge off by pressing the mains power switch.

7 Malfunctions and error correction

7 Malfunctions and error correction

7.1 General malfunctions

Malfunctions are indicated by error messages with a number in the speed/RCF display.

In the event of a fatal error (e.g. a defective lid lock), a certain safety time will be counted down on the display. During this time, "ERR" and "SAFE" flash alternately on the display. When the time is up, "OFF" will be displayed.



WARNING

Do not switch the centrifuge off until "OFF" is displayed! This is necessary in order to ensure that the rotor is at a complete standstill.

- Eliminate the source of the problem (see tables below).
- Acknowledge the error messages with the lid key.

| Type of error | Possible reason | Correction |
|--|--------------------------------------|---|
| No indication on the display | No power in the mains supply | Check fuse in the mains supply |
| | Power cord is not plugged in | Plug in power cord correctly |
| | Mains power switch off | Switch mains power switch on |
| | Lid is not closed correctly | Close the lid |
| Centrifuge cannot be started: The set speed value is displayed in an unchanged manner | Several possible causes | Netz aus/ein. Falls sich der Fehler wiederholt, Service verständigen |
| | The lid lock is not closed correctly | Open and close lid. If the error occurs again, contact service |
| Centrifuge decelerates during operation and displays an error from 1 to 18 after powering on | Several possible causes | Power off/on. If the error occurs again, contact service |
| Centrifuge decelerates during operation and displays error 19 after powering on | Several possible causes | Acknowledge by pressing the lid key |
| Lid cannot be opened | Lid locks have not released | Unlock the lid manually (see chapter 7.1.1 - "Emergency lid release") and contact service |
| | Lid seal sticks | Clean the lid seal and apply talcum powder |
| Temperature value cannot be reached (only for refrigerated centrifuges) | Condenser dirty | Contact service |

7.1.1 Emergency lid release

In the event of a power failure, it is possible to manually open the centrifuge lid.

- Switch off the mains power switch and disconnect the power cord from the socket.
- Remove the plug (see figure, item 1) from the opening on the left side of the control panel, e.g. with a screwdriver.



Fig. 9: Position of the opening for the emergency lid release

- Insert the supplied hexagon socket key horizontally into the hole and turn it anti-clockwise to the stop. The lid lock will then audibly unlock.



Fig. 10: Manual release of the lid lock

- Then, reinsert the plug.



WARNING

Do not unlock or open the lid unless the rotor is at a standstill.

If the lid is opened via the emergency lid release system during a centrifuge run, the centrifuge will be switched off immediately and decelerate in an unbraked manner.

7 Malfunctions and error correction

7.2 Table of error codes

| Error no. | Kind of error | Measures | Note |
|-----------|---|--|---|
| 1-9 | System error | <ul style="list-style-type: none"> Allow to slow down Power off/on | All these errors stop the centrifuge or cause it to decelerate brakeless |
| 10-19 | Speedometer error | <ul style="list-style-type: none"> Allow to slow down Power off/on | |
| 20-29 | Motor error | <ul style="list-style-type: none"> Power off Ensure ventilation | |
| 30-39 | EEPROM error | <ul style="list-style-type: none"> Allow to slow down Power off/on | With error 34, 35, and 36, the centrifuge will stop; with error 37 and 38 only an error message will be given |
| 40-45 | Temperature error (only for refrigerated centrifuges) | <ul style="list-style-type: none"> Allow to slow down Power off Allow to cool down Provide better ventilation (only air cooled centrifuges) Provide sufficient water throughput (only water cooled centrifuges) | |
| 46-49 | Imbalance error (only for centrifuges with imbalance monitoring system) | <ul style="list-style-type: none"> Allow to slow down Power off Eliminate the imbalance | |
| 50-59 | Lid error | <ul style="list-style-type: none"> Press lid key Close lid Remove foreign matter from the opening of the lid lock device | With error 50 and 51, the centrifuge will stop |
| 60-69 | Process error | <ul style="list-style-type: none"> Allow to slow down Power off/on | With error 60, the message "power failure during run" will be displayed, with error 61, the message "stop after power on" will be displayed |
| 70-79 | Communication error | <ul style="list-style-type: none"> Allow to slow down Power off/on | |
| 80-89 | Parameter error | <ul style="list-style-type: none"> Power off Allow to cool down Provide for better ventilation | With error 83, error message only |
| 90-99 | Other errors | <ul style="list-style-type: none"> Check connections Provide sufficient water throughput (only water cooled centrifuges) | |



If it is impossible to eliminate the errors, contact the service!

7.3 Service contact

In the event of queries, malfunctions, or spare part enquiries:

From Germany:

Contact

Sigma Laborzentrifugen GmbH
An der Unteren Söse 50
37520 Osterode (Germany)
Tel. +49 (0) 55 22 / 50 07-44 44
E-mail: support.lab@sigma-zentrifugen.de

Outside Germany:

Contact our agency in your country. All agencies are listed at
www.sigma-zentrifugen.de → [Sales Partners]



NOTE

- If you would like to utilise our service, please state the type of your centrifuge and its serial number.

8 Maintenance and service

8 Maintenance and service

The centrifuge, rotor, and accessories are subject to high mechanical stress. Thorough maintenance performed by the user extends the service life and prevents premature failure.



CAUTION

If corrosion or other damage occurs due to improper care, the manufacturer cannot be held liable or subject to any warranty claims.

- Use soap water or other water-soluble, mild cleaning agents with a pH value between 6 and 8 for cleaning the centrifuge and accessories (see also chapter 8.2 - "Sterilisation and disinfection of the rotor chamber and accessories").
- Avoid corrosive and aggressive substances.
- Do not use solvents.
- Do not use agents with abrasive particles.
- Do not expose the centrifuge and rotors to intensive UV radiation or thermal stress (e.g. by heat generators).

8.1 Maintenance

8.1.1 Centrifuge

- Unplug the mains power plug before cleaning.
- Carefully remove all liquids, including water and particularly all the solvents, acids, and alkaline solutions from the rotor chamber using a cloth in order to avoid damage to the motor bearings.
- If the centrifuge has been contaminated with toxic, radioactive, or pathogenic substances, clean the rotor chamber immediately with a suitable decontamination agent (depending on the type of contamination).



WARNING

Take suitable precautions for your own safety if there is a risk of toxic, radioactive, or pathogenic contamination.

- After every cleaning process, grease the motor shaft slightly with a small amount of heavy-duty grease for load-bearing bolts (part no. 71401) and distribute the grease with a cloth so that it forms a thin layer.

8.1.1.1 Condenser (only refrigerated centrifuges with an air-cooled refrigeration system)

In order to cool the refrigerant that is compressed by the refrigeration unit, centrifuges with an air-cooled refrigeration system use a lamellar condenser. It is cooled by air.

Dust and dirt obstruct the cooling flow of air. The dust on condenser pipes and lamellas reduces the heat exchange and thus the performance of the refrigeration unit.

This is why the installation site should be as clean as possible.

- Check the condenser at least once a month for dirt and clean it if necessary.
- If you have any queries, please contact service (see chapter 7.3 - "Service contact").

8.1.2 Accessories**CAUTION**

For the care of the accessories, special safety measures must be considered as these are measures that will ensure operational safety at the same time!

- Immediately rinse off the rotor, buckets, or accessories under running water if they have come into contact with any liquids that may cause corrosion. Use a brush for test tubes in order to clean the bores of angle rotors. Turn the rotor upside down and allow it to dry completely.
- Clean the accessories outside the centrifuge once a week or preferably after each use. Adapters should be removed, cleaned and dried.

**CAUTION****Do not clean the accessories in a dishwasher!**

Cleaning in a dishwasher removes the anodised coating; the result is cracking in areas that are subject to stress.

- If the rotors or accessories have been contaminated with toxic, radioactive, or pathogenic substances, clean them immediately with a suitable decontamination agent (depending on the type of contamination). Take suitable precautions for your own safety if there is a risk of toxic, radioactive, or pathogenic contamination.
- Dry the accessories with a soft cloth or in a drying chamber at approx. 50°C.

8 Maintenance and service

8.1.2.1 Plastic accessories

The chemical resistance of plastic decreases with rising temperatures (see chapter 11.4 - "Resistance data").

- If solvents, acids, or alkaline solutions have been used, clean the plastic accessories thoroughly.



WARNING

Plastic accessories must not be greased!

8.1.3 Rotors

The rotors are produced with the highest precision, in order to withstand the permanent high stress from high gravitational fields.

Chemical reactions as well as stress-corrosion (combination of oscillating pressure and chemical reaction) can affect or destroy the metals. Barely detectable cracks on the surface can expand and weaken the material without any visible signs.

- Check the material regularly (at least once a month) for
 - cracks
 - visible damage of the surface
 - pressure marks
 - signs of corrosion
 - other changes.
- Check the bores of the rotors and multiple carriers.
- Replace any damaged components immediately for your own safety.

8.1.4 Microhaematocrit rotor

- Remove the microhaematocrit rotor for cleaning.
- Wipe the centrifuge chamber clean.
- Replace the rubber ring in the event of wear or glass breakage (part no. 16003 for rotor 11024).

8.1.5 Glass breakage



CAUTION

In the case of glass breakage, immediately remove all glass particles (e.g. with a vacuum cleaner). Replace the rubber cushions since even thorough cleaning will not remove all glass particles.

Glass particles will damage the surface coating (e.g. anodising) of the buckets, which will then lead to corrosion.

Glass particles in the rubber cushions of the buckets will cause glass breakage again.

Glass particles on the pivot bearing of the load-bearing bolts prevent the buckets and carriers from swinging evenly, which will cause an imbalance.

Glass particles in the rotor chamber will cause metal abrasion due to the strong air circulation. This metal dust will not only pollute the rotor chamber, rotor, and materials to be centrifuged but also damage the surfaces of the accessories, rotors, and rotor chamber.

In order to completely remove the glass particles and metal dust from the rotor chamber:

- Grease the upper third of the rotor chamber with e.g. Vaseline.
- Then, let the rotor rotate for a few minutes at a moderate speed (approx. 2000 rpm). The glass and metal particles will now collect at the greased part.
- Remove the grease with the glass and metal particles with a cloth.
- If necessary, repeat this procedure.

8.2 Sterilisation and disinfection of the rotor chamber and accessories

- Use commercially-available disinfectants such as, for example, Sagrotan®, Buraton®, or Terralin® (available at chemist's shops or drugstores).
- The centrifuge and the accessories consist of various materials. A possible incompatibility must be considered.
- Before using cleaning or decontamination agents that were not recommended by us, contact the manufacturer to ensure that such a procedure will not damage the centrifuge.
- For autoclaving, consider the continuous heat resistance of the individual materials (see chapter 8.2.1 - "Autoclaving").

Please contact us if you have any queries (see chapter 7.3 - "Service contact").



DANGER

If dangerous materials (e.g. infectious and pathogenic substances) are used, the centrifuge and accessories must be disinfected.

8 Maintenance and service

8.2.1 Autoclaving

The service life of the accessories essentially depends on the frequency of autoclaving and use.

- Replace the accessories immediately when the parts show changes in colour or structure or in the occurrence of leaks etc.
- During autoclaving, the caps of the tubes must not be screwed on in order to avoid the deformation of the tubes.



NOTE

It cannot be excluded that plastic parts, e.g. lids or carriers, may deform during autoclaving.

| Accessories | Max. temp. (°C) | Min. time (min) | Max. time (min) | Max. cycles |
|--|-----------------|-----------------|-----------------|-------------|
| Aluminium buckets | 134-138 | 3 | 5 | - |
| Aluminium rotors | 134-138 | 3 | 5 | - |
| Glass tubes | 134-138 | 3 | 40 | - |
| Polyallomer / polycarbonate rectangular carriers | 115-118 | 30 | 40 | - |
| Polyallomer / polycarbonate round carriers | 115-118 | 30 | 40 | - |
| Polyamide buckets | 115-118 | 30 | 40 | 10 |
| Polycarbonate / polyallomer lids for angle rotors | 115-118 | 30 | 40 | 20 |
| Polycarbonate tubes | 115-118 | 30 | 40 | 20 |
| Polyphenylsulfone (PPSU) caps for buckets | 134-138 | 3 | 5 | 100 |
| Polypropylene balance adapter for blood-bag systems | 115-118 | 30 | 40 | n.s. |
| Polypropylene copolymer tubes | 115-121 | 30 | 40 | 20 |
| Polypropylene rectangular carriers | 115-118 | 30 | 40 | - |
| Polypropylene rotors | 115-118 | 30 | 40 | 20 |
| Polypropylene round carriers | 115-118 | 30 | 40 | - |
| Polysulfone caps for buckets | 134-138 | 3 | 5 | 100 |
| Polysulfone lids for angle rotors | 134-138 | 3 | 5 | 100 |
| Rubber adapters | 115-118 | 30 | 40 | - |
| Stainless-steel balance weight for blood-bag systems | 121 | 30 | 30 | n.s. |
| Teflon tubes | 134-138 | 3 | 5 | 100 |

8.3 Service



DANGER

In the event of service work that requires the removal of the panels, there is a risk of electric shock or mechanical injury.

- Only qualified specialist personnel is authorised to perform this service work.
- Following the completion of any type of service, the qualified and specialised personnel must perform final inspection and testing in compliance with the relevant standards.

The centrifuge is subject to high mechanical stress. In order to be able to withstand this high level of stress, high-quality components were used during the production of the centrifuge. Nevertheless, wear cannot be excluded and it may not be visible from the outside. Especially the rubber parts that are – among other things – part of the motor suspension, are subject to ageing.

This is why we recommend having the centrifuge checked by the manufacturer during an inspection once per year in the operating state and once every three years in the dismantled state. Rubber parts should be replaced after three years.

Information and appointments:

In Germany:

Contact

Sigma Laborzentrifugen GmbH

An der Unteren Söse 50

37520 Osterode (Germany)

Tel. +49 (0) 55 22 / 50 07-44 44

E-mail: support.lab@sigma-zentrifugen.de

Outside Germany:

Contact our agency in your country. All agencies are listed at www.sigma-zentrifugen.de → [Sales Partners]



- If you would like to utilise our service, please state the type of your centrifuge and its serial number.

8 Maintenance and service

8.4 Return of defective centrifuges or parts

Although we exercise great care during the production of our products, it may be necessary to return a unit or accessory to the manufacturer.

In order to ensure the quick and economical processing of returns of centrifuges, spare parts, or accessories, we require complete and extensive information concerning the process. Please fill in the following forms completely, sign them, enclose them with the return package, and send them together with the product to:

Sigma Laborzentrifugen GmbH
An der Unteren Söse 50
37520 Osterode (Germany)

1. Declaration of decontamination

As a certified company and due to the legal regulations for the protection of our employees and of the environment, we are obliged to certify the harmlessness of all incoming goods. For this purpose, we require a declaration of decontamination.

- The form must be filled in completely and signed by authorised and specialised personnel only.
- Affix the original form in a clearly visible manner to the outside of the packaging.



We will return the part/unit if no declaration of decontamination is provided!

2. Form for the return of defective parts

This form is for the product-related data. They facilitate the assignment, and they enable the quick processing of the return. If several parts are returned together in one packaging, please enclose a separate problem description for every defective part.

- A detailed problem description is necessary in order to perform the repair quickly and economically.



If the form does not include a description of the malfunction, neither a refund nor a credit note can be issued. In this case, we reserve the right to return the part/unit to you at your expense.

- Upon request, we will prepare and submit to you a cost estimate prior to performing the repair. Please confirm such cost estimate within 14 days. If the cost estimate has still not been confirmed after 4 weeks, we will return the defective part/unit. Please note that you must bear the incurred costs.



The defective part/unit must be packaged in a transport-safe manner. Please use the original packaging for the unit, if at all possible. If the product is dispatched to us in unsuitable packaging, you will be charged the cost for returning it to you in new packaging.

The forms can be downloaded online from
www.sigma-zentrifugen.de → [Service] → [Overhaul and repair].

9 Disposal

9 Disposal

9.1 Disposal of the centrifuge



In accordance with the directive 2012/19/EU, SIGMA centrifuges are marked with the symbol shown to the left. This symbol means that it is not permissible to dispose of the unit among household waste.

- You can return these centrifuges free of cost to Sigma Laborzentrifugen GmbH.
- Ensure that the unit is decontaminated. Fill in a declaration of decontamination (see chapter 8.4 - "Return of defective centrifuges or parts").
- Comply with any other applicable local rules and regulations.

9.2 Disposal of the packaging

- Use the packaging to return the centrifuge for disposal or
- dispose of the packaging, after having separated the individual materials.
- Comply with all local rules and regulations.

10 Technical data

| | | |
|----------------------------------|--|---------------------|
| Manufacturer: | Sigma Laborzentrifugen GmbH An der Unteren Söse 50 37520 Osterode (Germany) | |
| Type: | 1-16K | 1-16K IVD |
| Order no.: | 10030, 10031, 10032 | 10040, 10041, 10042 |
| <u>Connection requirements</u> | | |
| Electrical connection: | see name plate | |
| Protection class: | I | |
| IP code: | 20 | |
| Power consumption (kW): | 0.42 (at 220-240 V / 50/60 Hz) 0.46 (at 120 V / 60 Hz) 0.55 (at 100 V / 50/60 Hz) | |
| Input fuse (AT): | 4.0 (at 220-240 V / 50/60 Hz) 10.0 (at 120 V / 60 Hz) 10.0 (at 100 V / 50/60 Hz) | |
| <u>Performance data</u> | | |
| Max. speed (rpm): | 15,000 | |
| Max. capacity (ml): | 72 | |
| Max. gravitational field (x g): | 20,627 | |
| Max. kinetic energy (Nm): | 5,176 | |
| <u>Other parameters</u> | | |
| Time range: | 10 sec – 99 min 59 sec, short run, continuous run | |
| Temperature range: | -10°C to +40°C | |
| <u>Physical data</u> | | |
| Height (mm): | 291 | |
| Height with open lid (mm): | 547 | |
| Width (mm): | 310 | |
| Depth (mm): | 660 | |
| Weight (kg): | 32 | |
| Noise level (dB(A)): | 59 (at max. speed) | |
| <u>Refrigerant data</u> | | |
| Refrigerant: | R134a | |
| Filling quantity (kg): | 0.136 | |
| Max. permissible pressure (bar): | 23 | |
| CO ₂ equivalent (t): | 0.177 | |

10 Technical data

| | | |
|----------------------------------|--|---------------------|
| Manufacturer: | Sigma Laborzentrifugen GmbH An der Unteren Söse 50 37520 Osterode (Germany) | |
| Type: | 1-16K | 1-16K IVD |
| Order no.: | 10046, 10047, 10048 | 10052, 10053, 10054 |
| <u>Connection requirements</u> | see name plate | |
| Electrical connection: | I | |
| Protection class: | 20 | |
| IP code: | 20 | |
| Power consumption (kW): | 0.54 (at 220-240 V / 50/60 Hz) 0.54 (at 120 V / 60 Hz) 0.54 (at 100 V / 50/60 Hz) | |
| Input fuse (AT): | 10.0 (at 220-240 V / 50/60 Hz) 10.0 (at 120 V / 60 Hz) 10.0 (at 100 V / 50/60 Hz) | |
| <u>Performance data</u> | | |
| Max. speed (rpm): | 15,000 | |
| Max. capacity (ml): | 72 | |
| Max. gravitational field (x g): | 20,627 | |
| Max. kinetic energy (Nm): | 5,176 | |
| <u>Other parameters</u> | | |
| Time range: | 10 sec – 99 min 59 sec, short run, continuous run | |
| Temperature range: | -10°C to +40°C | |
| <u>Physical data</u> | | |
| Height (mm): | 291 | |
| Height with open lid (mm): | 547 | |
| Width (mm): | 310 | |
| Depth (mm): | 660 | |
| Weight (kg): | 34 | |
| Noise level (dB(A)): | 54 (at max. speed) | |
| <u>Refrigerant data</u> | | |
| Refrigerant: | R134a | |
| Filling quantity (kg): | 0.136 | |
| Max. permissible pressure (bar): | 23 | |
| CO ₂ equivalent (t): | 0.177 | |

10.1 Ambient conditions

- The figures are valid for an ambient temperature of +23°C and a nominal voltage $\pm 10\%$. The minimum temperature is $\leq +4^\circ\text{C}$ and depends on the rotor type, speed, and ambient temperature.



At a nominal voltage of 100V or 200V, a tolerance of +10% / -5% applies.

- For indoor use only.
- Allowable ambient temperature +5°C to +35°C.
- Max. allowable relative humidity of air 80% from 5°C up to 31°C with a linear decrease to 67% relative humidity of air at 35°C.
- Maximum altitude 2,000 m above sea level.

10.2 Technical documentation

For environmental reasons, the comprehensive technical documentation of the centrifuge (e.g. circuit diagrams) and the safety data sheets of the manufacturers of refrigerants and lubricants are not attached to this documentation.

You can order these documents from our service department.

11 Appendix

11 Appendix

11.1 Range of accessories

The complete list of accessories can be downloaded from www.sigma-zentrifugen.de.

11.1.1 Rotor radii

The information in the accessories table concerning the radius refers to the values of the respective rotor as shown below. The radius calculation is described in chapter 2.2.2.1 - "Speed, radius, and relative centrifugal force".

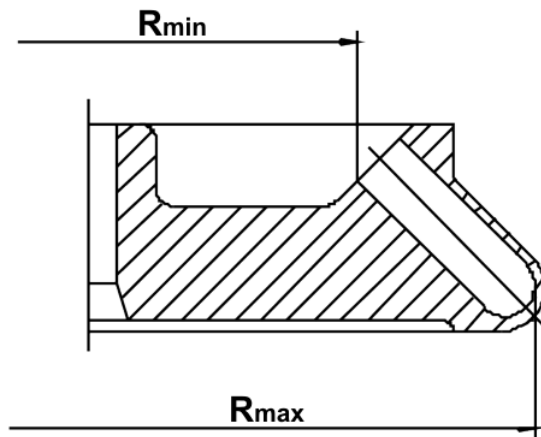

Fig. 11: Minimum and maximum radius of an angle rotor

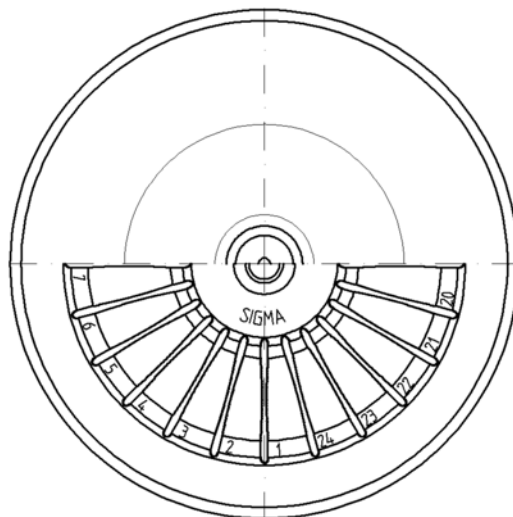

Fig. 12: Microhaematocrit rotor

11.2 Speed-gravitational-field-diagram

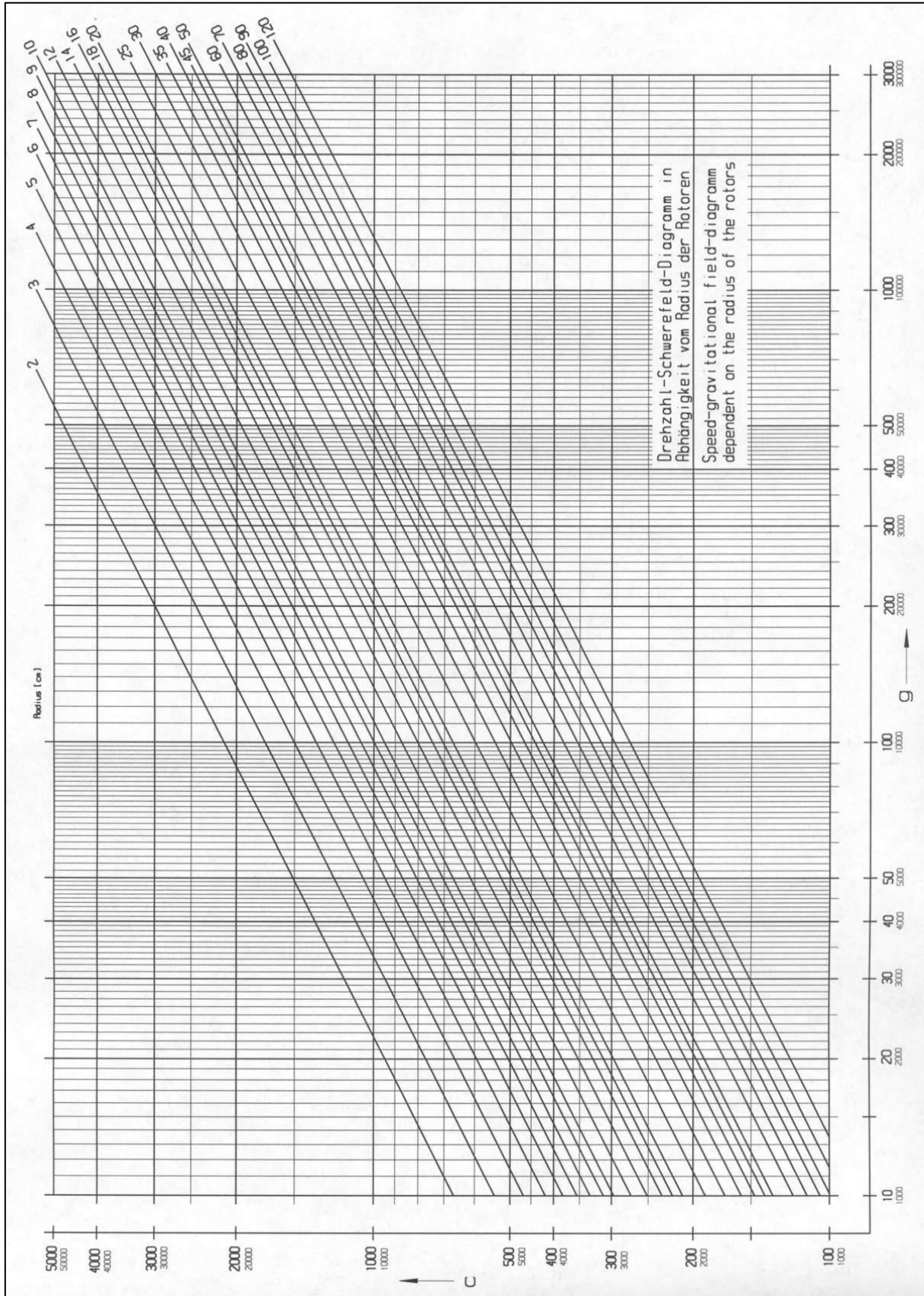

Fig. 13: Speed-gravitational-field-diagram

11 Appendix

11.3 Table of the service life of rotors and accessories

- If no other data concerning the service life are engraved on the rotor or accessory, rotors and buckets must be checked by the manufacturer after 10 years.
- If a specification concerning the maximum number of cycles **and** a specification concerning the service life (i.e. a date) are provided, the specification that occurs first shall apply.
- After 50,000 cycles, rotors must be scrapped for safety reasons.

| Rotor / bucket | Cycles | Service life ("Exp.Date") | Autoclaving | Suitable for centrifuge | Remarks |
|----------------|---------|---------------------------|-------------|---|--|
| 9100 | 15,000 | | | 4-15C, 4K15C, 4-16, 4-16S, 4-16K, 4-16KS, 6-15, 6K15, 6-16, 6-16K | without engraving, only "spincontrol professional" and "spincontrol S" |
| 11026 | | 7 years | | 1-14, 1-14K | |
| 11805 / 13850 | 10,000 | 10 years | | 8K, 8KB, 8KS, 8KBS | |
| 11805 / 13860 | 10,000 | 10 years | | 8K, 8KB, 8KS, 8KBS | |
| 11806 | | 10 years | | 8K, 8KB, 8KS, 8KBS | |
| 12033 | | 5 years | | 1-16 Edition, 1-16K Edition | |
| 12082 | | 7 years | | 1-14, 1-14K | |
| 12083 | | 7 years | | 1-14, 1-14K | |
| 12084 | | 7 years | | 1-14, 1-14K | |
| 12085 | | 7 years | | 1-14, 1-14K | |
| 12092 | | 5 years | 20x | 1-14, 1-14K | |
| 12093 | | 5 years | 20x | 1-14, 1-14K | |
| 12094 | | 5 years | 20x | 1-14, 1-14K | |
| 12096 | | 5 years | 20x | 1-14, 1-14K | |
| 12097 | | 5 years | 20x | 1-14, 1-14K | |
| 12101 | | 5 years | 20x | 1-15, 1-15K, 1-15P, 1-15PK | |
| 12124 | | 5 years | 20x | 1-15, 1-15K, 1-15P, 1-15PK | |
| 12126 | | 5 years | 20x | 1-15, 1-15K, 1-15P, 1-15PK | |
| 12134 | | 5 years | 20x | 1-16, 1-16K | |
| 12135 | | 5 years | 20x | 1-16, 1-16K | |
| 12137 | | 5 years | 20x | 1-16, 1-16K | |
| 12500 | | 7 years | | 6-15, 6K15, 6-16, 6-16K | |
| 12600 | | 7 years | | 6-16S, 6-16KS | |
| 13218 | 20,000 | | | 4-16, 4-16S, 4-16K, 4-16KS, 6-16, 6-16S, 6-16K, 6-16KS | |
| 13296 | 35,000 | 5 years | 10x | 2-6, 2-6E, 2-7, 2-16P, 2-16KL, 2-16KHL | |
| 13299 | | 5 years | 10x | 2-6, 2-6E, 2-7, 2-16P, 2-16KL, 2-16KHL | |
| 13635 | 25,000 | | | 6-16, 6-16K, 6-16S, 6-16KS | |
| 13650 | 20,000 | | | 4-5L, 4-16S, 4-16KS, 4-16KHS, 6-16S, 6-16HS, 6-16KS, 6-16KHS | |
| 13845 | 20,000 | | | 8K, 8KB, 8KS, 8KBS | |
| 13850 | 10,000* | 10 years | | 8K, 8KB, 8KS, 8KBS | *in combination with rotor 11805 |
| 13860 | 15,000* | 10 years | | 8K, 8KB, 8KS, 8KBS | *in combination with rotor 11805 |
| 13864 | 1,000 | | | 8K, 8KB, 8KS, 8KBS | without engraving |
| 13865 | 1,000 | | | 8K, 8KB, 8KS, 8KBS | without engraving |
| 13866 | 1,000 | | | 8K, 8KB, 8KS, 8KBS | without engraving |
| 13867 | 2,500 | | | 8K, 8KB, 8KS, 8KBS | without engraving |
| 13868 | 5,000 | | | 8K, 8KB, 8KS, 8KBS | without engraving |
| 13869 | 5,000 | | | 8K, 8KB, 8KS, 8KBS | without engraving |
| 13870 | 5,000 | | | 8K, 8KB, 8KS, 8KBS | without engraving |

11.4 Resistance data



The data refer to resistance at 20°C.

| - no data 1 resistant 2 practically resistant 3 partially resistant 4 not resistant | Medium | Formula | Concentration [%] | High Density Polyethylene | Polyamide | Polycarbonate | Polyoxymethylene | Polypropylene | Polysulfone | Polyvinyl chloride, hard | Polyvinyl chloride, soft | Polytetrafluorethylene | Acrylonitrile-butadiene- caoutchouc | Aluminium |
|---|------------------------------|---|----------------------|------------------------------|-----------|---------------|------------------|---------------|-------------|--------------------------|--------------------------|------------------------|--|-----------|
| | | | | HDPE | PA | PC | POM | PP | PSU | PVC | PVC | PTFE | NBR | AL |
| | Acetaldehyde | C ₂ H ₄ O | 40 | 3 | 2 | 4 | 2 | 3 | 4 | 4 | - | 1 | 4 | 1 |
| | Acetamide | C ₂ H ₅ NO | saturated | 1 | 1 | 4 | 1 | 1 | 4 | 4 | - | 1 | - | 1 |
| | Acetone | C ₃ H ₆ O | 100 | 1 | 1 | 4 | 1 | 1 | 4 | 4 | - | 1 | 4 | 1 |
| | Acrylonitrile | C ₃ H ₃ N | 100 | 1 | 1 | 4 | 3 | 3 | 4 | 4 | 4 | 1 | 4 | 1 |
| | Allyl alcohol | C ₃ H ₆ O | 96 | 1 | 3 | 3 | 2 | 2 | 2 | 2 | 4 | 1 | 1 | 1 |
| | Aluminium chloride | AlCl ₃ | saturated | 1 | 3 | 2 | 4 | 1 | - | 1 | - | 1 | 1 | 4 |
| | Aluminium sulfate | Al ₂ (SO ₄) ₃ | 10 | 1 | 1 | 1 | 3 | 1 | 1 | 1 | 1 | 1 | 1 | 1 |
| | Ammonium chloride | (NH ₄)Cl | aqueous | 1 | 1 | 1 | 2 | 1 | 1 | 1 | 1 | 1 | 1 | 3 |
| | Ammonium hydroxide | NH ₃ + H ₂ O | 30 | 1 | 3 | 4 | 1 | 1 | 2 | 1 | - | 1 | - | 1 |
| | Aniline | C ₆ H ₇ N | 100 | 1 | 3 | 4 | 1 | 2 | 4 | 4 | 4 | 1 | 4 | 1 |
| | Anisole | C ₇ H ₈ O | 100 | 3 | 4 | 4 | 1 | 4 | 4 | 2 | - | 1 | 4 | 1 |
| | Antimony trichloride | SbCl ₃ | 90 | 1 | 4 | 1 | 4 | 1 | - | 1 | - | 1 | - | 4 |
| | Benzaldehyde | C ₇ H ₆ O | 100 | 1 | 3 | 4 | 1 | 1 | 3 | 4 | 4 | 1 | 4 | 1 |
| | Benzene | C ₆ H ₆ | 100 | 3 | 2 | 4 | 1 | 3 | 4 | 4 | - | 1 | 4 | 1 |
| | Boric acid | H ₃ BO ₃ | aqueous | 1 | 3 | 1 | 2 | 1 | - | - | - | 1 | 1 | 1 |
| | Butyl acrylate | C ₇ H ₁₂ O ₂ | 100 | 1 | 2 | 4 | 2 | 3 | 4 | 4 | 4 | 1 | - | 1 |
| | Butyl alcohol, normal | C ₄ H ₁₀ O | 100 | 1 | 1 | 2 | 1 | 1 | 2 | 2 | 4 | 1 | 1 | 1 |
| | Calcium chloride | CaCl ₂ | alcoholic | 1 | 4 | 2 | 3 | 1 | - | - | 4 | 1 | 1 | 3 |
| | Carbon disulfide | CS ₂ | 100 | 4 | 3 | 4 | 2 | 4 | 4 | 4 | 4 | 1 | 3 | 1 |
| | Carbon tetrachloride (TETRA) | CCl ₄ | 100 | 4 | 4 | 4 | 2 | 4 | 4 | 4 | 4 | 1 | 3 | 1 |
| | Chlorine | Cl ₂ | 100 | 4 | 4 | 4 | 4 | 4 | 4 | 4 | 4 | 1 | - | 3 |
| | Chlorine water | Cl ₂ x H ₂ O | | 3 | 4 | 4 | 4 | 3 | - | 3 | 3 | 1 | - | 4 |
| | Chlorobenzene | C ₆ H ₅ Cl | 100 | 3 | 4 | 4 | 1 | 3 | 4 | 4 | 4 | 1 | 4 | 1 |
| | Chloroform | CHCl ₃ | 100 | 3 | 3 | 4 | 4 | 3 | 4 | 4 | 4 | 1 | 4 | 3 |

11 Appendix

| - no data 1 resistant 2 practically resistant 3 partially resistant 4 not resistant | Medium | Formula | Concentration [%] | High Density Polyethylene | Polyamide | Polycarbonate | Polyoxymethylene | Polypropylene | Polysulfone | Polyvinyl chloride, hard | Polyvinyl chloride, soft | Polytetrafluorethylene | Acrylonitrile-butadiene- caoutchouc | Aluminium |
|---|---------------------------------------|--|----------------------|------------------------------|-----------|---------------|------------------|---------------|-------------|--------------------------|--------------------------|------------------------|--|-----------|
| | | | | HDPE | PA | PC | POM | PP | PSU | PVC | PVC | PTFE | NBR | AL |
| | Chromic acid | CrO ₃ | 10 | 1 | 4 | 2 | 4 | 1 | 4 | 1 | - | 1 | 4 | 1 |
| | Chromic potassium sulphate | KCr(SO ₄) ₂ x 12H ₂ O | saturated | 1 | 2 | 1 | 3 | 1 | - | 1 | - | 1 | - | 3 |
| | Citric acid | C ₆ H ₈ O ₇ | 10 | 1 | 1 | 1 | 2 | 1 | 1 | 1 | 1 | 1 | 1 | 1 |
| | Citric acid | C ₆ H ₈ O ₇ | 50 | 1 | 3 | 1 | 2 | 1 | - | - | - | 1 | 1 | 1 |
| | Copper sulphate | CuSO ₄ x 5H ₂ O | 10 | 1 | 1 | 1 | 1 | 1 | 1 | 1 | 1 | 1 | 1 | 4 |
| | Cyclohexanol | C ₆ H ₁₂ O | 100 | 1 | 1 | 3 | 1 | 1 | 1 | 1 | 4 | 1 | 2 | 1 |
| | Decane | C ₁₀ H ₂₂ | 100 | - | 1 | 2 | 1 | 3 | - | - | - | 1 | 2 | 1 |
| | Diaminoethane | C ₂ H ₈ N ₂ | 100 | 1 | 1 | 3 | 1 | 1 | - | 3 | 4 | 1 | 1 | 1 |
| | Diesel fuel | — | 100 | 1 | 1 | 3 | 1 | 1 | - | 1 | 3 | 1 | 1 | 1 |
| | Dimethyl formamide (DMF) | C ₃ D ₇ NO | 100 | 1 | 1 | 4 | 1 | 1 | 4 | 3 | - | 1 | 3 | 1 |
| | Dimethyl sulfoxide (DMSO) | C ₂ H ₆ SO | 100 | 1 | 2 | 4 | 1 | 1 | 4 | 4 | - | 1 | - | 1 |
| | Dimethylaniline | C ₈ H ₁₁ N | 100 | - | 3 | 4 | 2 | 4 | - | - | - | 1 | - | 1 |
| | Dioxane | C ₄ H ₈ O ₂ | 100 | 2 | 1 | 4 | 1 | 3 | 2 | 3 | 4 | 1 | 3 | 1 |
| | Dipropylene glycol (mono)methyl ether | C ₄ H ₁₀ O | 100 | 3 | 1 | 4 | 1 | 4 | 4 | 4 | 4 | 1 | - | 1 |
| | Ethyl acetate | C ₄ H ₈ O ₂ | 100 | 1 | 1 | 4 | 1 | 1 | 4 | 4 | 4 | 1 | 4 | 1 |
| | Ethylene chloride | C ₂ H ₄ Cl ₂ | 100 | 3 | 3 | 4 | 1 | 3 | 4 | 4 | 4 | 1 | - | 1 |
| | Ferrous chloride | FeCl ₂ | saturated | 1 | 3 | 1 | 3 | 1 | 1 | 1 | 1 | 1 | - | 4 |
| | Formaldehyde solution | CH ₂ O | 30 | 1 | 3 | 1 | 1 | 1 | - | - | - | 1 | 2 | 1 |
| | Formic acid | CH ₂ O ₂ | 100 | 1 | 4 | 3 | 4 | 1 | 3 | 3 | 1 | 1 | 2 | 1 |
| | Furfural | C ₅ H ₄ O ₂ | 100 | 1 | 3 | 3 | 2 | 4 | - | - | - | 1 | 4 | 1 |
| | Gasoline | C ₅ H ₁₂ - C ₁₂ H ₂₆ | 100 | 2 | 1 | 3 | 1 | 3 | 3 | 2 | - | 1 | 1 | 1 |
| | Glycerol | C ₃ H ₈ O ₃ | 100 | 1 | 1 | 3 | 1 | 1 | 1 | 1 | 2 | 1 | 1 | 1 |
| | Heptane, normal | C ₇ H ₁₆ | 100 | 2 | 1 | 1 | 1 | 2 | 1 | 2 | 4 | 1 | 1 | 1 |
| | Hexane, n- | C ₆ H ₁₄ | 100 | 2 | 1 | 2 | 1 | 2 | 1 | 2 | 4 | 1 | 1 | 1 |
| | Hydrogen chloride | HCl | 5 | 1 | 4 | 1 | 4 | 1 | 1 | 1 | - | 1 | 2 | 4 |
| | Hydrogen chloride | HCl | concentrated | 1 | 4 | 4 | 4 | 1 | 1 | 2 | 3 | 1 | 4 | 4 |
| | Hydrogen peroxide | H ₂ O ₂ | 3 | 1 | 3 | 1 | 1 | 1 | 1 | 1 | - | 1 | 3 | 3 |
| | Hydrogen peroxide | H ₂ O ₂ | 30 | 1 | 4 | 1 | 4 | 1 | 1 | 1 | - | 1 | 3 | 3 |
| | Hydrogen sulphide | H ₂ S | 10 | 1 | 1 | 1 | 1 | 1 | 1 | 1 | 3 | 1 | 3 | 1 |
| | Iodine, tincture of | I ₂ | | 1 | 4 | 3 | 1 | 1 | - | 4 | 4 | 1 | 1 | 1 |

11 Appendix

| - no data 1 resistant 2 practically resistant 3 partially resistant 4 not resistant | Medium | Formula | Concentration [%] | High Density Polyethylene | Polyamide | Polycarbonate | Polyoxymethylene | Polypropylene | Polysulfone | Polyvinyl chloride, hard | Polyvinyl chloride, soft | Polytetrafluorethylene | Acrylonitrile-butadiene- caoutchouc | Aluminium |
|---|--|-----------|----------------------|------------------------------|-----------|---------------|------------------|---------------|-------------|--------------------------|--------------------------|------------------------|--|-----------|
| | | | | HDPE | PA | PC | POM | PP | PSU | PVC | PVC | PTFE | NBR | AL |
| Isopropyl alcohol | C ₃ H ₈ O | 100 | 1 | 1 | 1 | 1 | 1 | 1 | 1 | 1 | 4 | 1 | - | 2 |
| Lactic acid | C ₃ H ₆ O ₃ | 3 | 1 | 3 | 1 | 2 | 1 | 1 | 1 | 2 | - | 1 | 1 | 1 |
| Magnesium chloride | MgCl ₂ | 10 | 1 | 1 | 1 | 1 | 1 | 1 | 1 | 1 | 1 | 1 | 1 | 1 |
| Mercuric chloride | HgCl ₂ | 10 | 1 | 4 | 1 | 3 | 1 | 1 | 1 | 1 | 1 | 1 | 1 | 4 |
| Mercury | Hg | 100 | 1 | 1 | 1 | 1 | 1 | 1 | 1 | 1 | 3 | 1 | 1 | 3 |
| Methyl acetate | C ₃ H ₆ O ₂ | 100 | 1 | 1 | 4 | 2 | 1 | - | 4 | 4 | 1 | - | 1 | 1 |
| Methyl alcohol | CH ₄ O | 100 | 1 | 2 | 4 | 1 | 1 | 3 | 1 | 3 | 1 | 2 | 1 | 1 |
| Methyl benzene | C ₇ H ₈ | 100 | 3 | 1 | 4 | 1 | 3 | 4 | 4 | 4 | 1 | 4 | 1 | 1 |
| Methyl ethyl ketone (MEK) | C ₄ H ₈ O | 100 | 1 | 1 | 4 | 1 | 1 | 4 | 4 | 4 | 1 | 4 | 1 | 1 |
| Methylene chloride | CH ₂ Cl ₂ | 100 | 4 | 3 | 4 | 3 | 3 | 4 | 4 | 4 | 1 | - | 1 | 1 |
| Mineral oil | — | 100 | 1 | 1 | 1 | 1 | 1 | 1 | 1 | 1 | - | 1 | 1 | 1 |
| Nitric acid | HNO ₃ | 10 | 1 | 4 | 1 | 4 | 1 | 1 | 1 | 1 | - | 1 | 4 | 3 |
| Nitric acid | HNO ₃ | 100 | 4 | 4 | 4 | 4 | 4 | - | 4 | - | 1 | 4 | 1 | 1 |
| Nitrobenzene | C ₆ H ₅ NO ₂ | 100 | 3 | 4 | 4 | 3 | 2 | 4 | 4 | 4 | 1 | 4 | 1 | 1 |
| Oleic acid | C ₁₈ H ₃₄ O ₂ | 100 | 1 | 1 | 1 | 2 | 1 | - | 1 | - | 1 | 3 | 1 | 1 |
| Oxalic acid | C ₂ H ₂ O ₄ x 2H ₂ O | 100 | 1 | 3 | 1 | 4 | 1 | 1 | 1 | 1 | 1 | 2 | 1 | 1 |
| Ozone | O ₃ | 100 | 3 | 4 | 1 | 4 | 3 | 1 | 1 | 1 | - | 1 | 4 | 2 |
| Petroleum | — | 100 | 1 | 1 | 3 | 1 | 1 | 1 | 1 | 1 | 3 | 1 | 1 | 1 |
| Phenol | C ₆ H ₆ O | 10 | 1 | 4 | 4 | 4 | 1 | 4 | 1 | 3 | 1 | 3 | 1 | 1 |
| Phenol | C ₆ H ₆ O | 100 | 2 | 4 | 4 | 4 | 1 | 3 | 4 | 3 | 1 | 3 | 1 | 1 |
| Phosphoric acid | H ₃ PO ₄ | 20 | 1 | 4 | 2 | 4 | 1 | - | - | - | 1 | 2 | 4 | 4 |
| Phosphorus pentachloride | PCl ₅ | 100 | - | 4 | 4 | 4 | 1 | - | 4 | 4 | 1 | - | 1 | 1 |
| Potassium hydrogen carbonate | CHKO ₃ | saturated | 1 | 1 | 2 | 1 | 1 | - | - | - | 1 | - | 4 | 4 |
| Potassium hydroxide | KOH | 30 | 1 | 1 | 4 | 3 | 1 | 1 | 1 | 1 | 1 | - | 4 | 4 |
| Potassium hydroxide | KOH | 50 | 1 | 1 | 4 | 3 | 1 | 1 | 1 | 1 | 1 | - | 4 | 4 |
| Potassium nitrate | KNO ₃ | 10 | 1 | 1 | 1 | 1 | 1 | - | - | - | 1 | 1 | 1 | 1 |
| Potassium permanganate | KMnO ₄ | 100 | 1 | 4 | 1 | 1 | 1 | - | 1 | - | 1 | 3 | 1 | 1 |
| Pyridine | C ₅ H ₅ N | 100 | 1 | 1 | 4 | 1 | 3 | 4 | 4 | 4 | 1 | 4 | 1 | 1 |
| Resorcinol | C ₆ H ₆ O ₂ | 5 | 1 | 4 | 2 | 3 | 1 | 4 | 2 | - | 1 | - | 2 | 2 |
| Silver nitrate | AgNO ₃ | 100 | 1 | 1 | 1 | 1 | 1 | 1 | 1 | 1 | 1 | 2 | 4 | 4 |

11 Appendix

| - no data 1 resistant 2 practically resistant 3 partially resistant 4 not resistant | | Concentration | High Density Polyethylene | Polyamide | Polycarbonate | Polyoxymethylene | Polypropylene | Polysulfone | Polyvinyl chloride, hard | Polyvinyl chloride, soft | Polytetrafluorethylene | Acrylonitrile-butadiene-caoutchouc | Aluminium | |
|---|-----------------------|---|---------------------------|-----------|---------------|------------------|---------------|-------------|--------------------------|--------------------------|------------------------|------------------------------------|-----------|------|
| | | | Medium | Formula | [%] | HDPE | PA | PC | POM | PP | PSU | PVC | PVC | PTFE |
| | Sodium bisulphite | NaHSO ₃ | 10 | 1 | 1 | 2 | 4 | 1 | - | - | - | 1 | 1 | 1 |
| | Sodium carbonate | Na ₂ CO ₃ | 10 | 1 | 1 | 1 | 1 | 1 | - | - | - | 1 | - | 3 |
| | Sodium chloride | NaCl | 30 | 1 | 1 | 1 | 1 | 1 | 1 | 1 | 1 | 1 | 1 | 3 |
| | Sodium hydroxide | NaOH | 30 | 1 | 1 | 4 | 1 | 1 | 1 | 1 | 1 | 1 | 2 | 4 |
| | Sodium hydroxide | NaOH | 50 | 1 | 1 | 4 | 1 | 1 | 1 | 1 | - | 1 | 2 | 4 |
| | Sodium sulfate | Na ₂ SO ₄ | 10 | 1 | 1 | 1 | 1 | 1 | 1 | 1 | 1 | 1 | 1 | 1 |
| | Spirits | C ₂ H ₆ O | 96 | 1 | 1 | 1 | 1 | 1 | 1 | 1 | 3 | 1 | - | 1 |
| | Styrene | C ₈ H ₈ | 100 | 4 | 1 | 4 | 1 | 3 | - | 4 | 4 | 1 | 4 | 1 |
| | Sulphuric acid | H ₂ SO ₄ | 6 | 1 | 4 | 1 | 4 | 1 | 1 | 1 | - | 1 | 2 | 3 |
| | Sulphuric acid | H ₂ SO ₄ | fuming | 4 | 4 | 4 | 4 | 4 | 4 | 4 | 4 | 1 | 4 | 3 |
| | Tallow | — | 100 | 1 | 1 | 1 | 1 | 1 | - | 1 | 1 | 1 | 1 | 1 |
| | Tetrahydrofuran (THF) | C ₄ H ₈ O | 100 | 3 | 1 | 4 | 1 | 3 | 4 | 4 | 4 | 1 | 3 | 1 |
| | Tetrahydronaphthalene | C ₁₀ H ₁₂ | 100 | 3 | 1 | 4 | 1 | 4 | 4 | 4 | 4 | 1 | - | 1 |
| | Thionyl chloride | Cl ₂ SO | 100 | 4 | 4 | 4 | 2 | 4 | 4 | 4 | 4 | 1 | - | 3 |
| | Tin chloride | SnCl ₂ | 10 | 1 | 4 | 2 | 2 | 1 | - | - | - | 1 | 1 | 4 |
| | Transformer oil | — | 100 | 1 | 1 | 3 | 3 | 1 | 1 | 1 | - | 1 | 1 | 1 |
| | Trichloroethane | C ₂ H ₃ Cl ₃ | 100 | 3 | 3 | 4 | 2 | 4 | 4 | 4 | 4 | 1 | 4 | 4 |
| | Urea | CH ₄ N ₂ O | 10 | 1 | 1 | 1 | 1 | 1 | - | - | - | 1 | 1 | 1 |
| | Urine | — | 100 | 1 | 1 | 1 | 1 | 1 | - | 1 | 1 | 1 | - | 2 |
| | Vinegar | C ₂ H ₄ O ₂ | 10 | 1 | 4 | 1 | 1 | 1 | 1 | 1 | 1 | 1 | 2 | 1 |
| | Vinegar | C ₂ H ₄ O ₂ | 90 | 1 | 4 | 4 | 4 | 1 | 3 | 1 | 4 | 1 | - | 1 |
| | Wax | — | 100 | - | 1 | 1 | | 1 | - | - | - | 1 | - | 1 |
| | Wines | — | 100 | 1 | 1 | 1 | 2 | 1 | 1 | 1 | 1 | 1 | - | 4 |
| | Xylene | C ₈ H ₁₀ | 100 | 3 | 1 | 4 | 1 | 4 | 4 | 4 | 4 | 1 | 4 | 1 |

11.5 EC declaration of conformity



EC – DECLARATION OF CONFORMITY

The product named hereinafter was developed, designed, and manufactured in compliance with the relevant, fundamental safety and health requirements of the listed EC directives and norms.

In the event of modifications that were not authorised by us or if the product is used in a manner that is not in line with the intended purpose, this declaration will be rendered void.

| | |
|----------------------|--|
| <i>Product name:</i> | Laboratory centrifuge |
| <i>Product type:</i> | Sigma 1-16K |
| <i>Order number:</i> | 10030, 10031, 10032, 10033, 10046, 10047, 10048 |
| <i>Directives:</i> | 2006/42/EC Machinery Directive 2014/35/EU Low Voltage Directive 2014/30/EU EMC Directive (EU) 2015/863 RoHS Directive |
| <i>Normes:</i> | EN 61010-2-020:2017 EN 61010-2-011:2017 EN IEC 61000-3-2:2019 EN 61000-3-3:2013 EN 61326-1:2013 |

Sigma Laborzentrifugen GmbH

An der Unteren Söse 50
37520 Osterode
Germany

Authorised representative
for CE matters:
Eckhard Tödteberg

Osterode, 07/04/2020



General Manager

11 Appendix



EC – DECLARATION OF CONFORMITY

The product named hereinafter was developed, designed, and manufactured in compliance with the relevant, fundamental safety and health requirements of the listed EC directives and norms.

In the event of modifications that were not authorised by us or if the product is used in a manner that is not in line with the intended purpose, this declaration will be rendered void.

| | |
|----------------------|--|
| <i>Product name:</i> | Laboratory centrifuge |
| <i>Product type:</i> | Sigma 1-16K IVD |
| <i>Order number:</i> | 10040, 10041, 10042, 10052, 10053, 10054 |
| <i>Directives:</i> | 98/79/EC In vitro Diagnostica (EU) 2015/863 RoHS Directive |
| <i>Normes:</i> | EN 61010-2-101:2017 EN 61010-2-020:2017 EN 61010-2-011:2017 EN IEC 61000-3-2:2019 EN 61000-3-3:2013 EN 61326-1:2013 |

Sigma Laborzentrifugen GmbH

An der Unteren Söse 50
37520 Osterode
Germany

Authorised representative
for CE matters:
Eckhard Tödteberg

Osterode, 07/04/2020



General Manager

11 Appendix

11.6 Declaration of conformity – China RoHS 2



DECLARATION OF CONFORMITY

China RoHS 2 (Administrative Measures for the Restriction of the Use of Hazardous Substances in Electrical and Electronic Products)

Laboratory centrifuge models: Sigma 1-14, 1-14K, 1-7, 1-16, 1-16K, 2-7, 2-16P, 2-16KL, 2-16KHL, 3-16L, 3-16KL, 3-18KS, 3-18KHS, 3-30KS, 3-30KHS, 4-5L, 4-5KRL, 4-16S, 4-16KS, 4-16KHS, 4-16KRL, 6-16S, 6-16HS, 6-16KS, 6-16KHS, 6-16KRL, 8KS, 8KBS

Sigma Laborzentrifugen GmbH has made reasonable effort to avoid the use of hazardous substances in the products it manufactures (laboratory centrifuges).

A Product Conformity Assessment (PCA) was performed in order to determine whether the concentration of harmful substances in all homogeneous materials of the component parts is above or below the MCV limit (Maximum Concentration Value limit) as defined in GB/T 26572:

Mercury and its compounds: 0.1 % Cadmium (Cd) and its compounds: 0.01 %
 Lead (Pb) and its compounds: 0.1 % Hexavalent chromium (Cr (VI)) and its compounds: 0.1 %
 Polybrominated biphenyls (PBB): 0.1 % Polybrominated diphenyl ethers (PBDE): 0.1 %

表1 产品中有害物质的名称及含量
 Table 1: Name and content of hazardous substances in the product

| 部件名称 Component part (PCA) | 有害物质 Hazardous substance | | | | | |
|------------------------------|-----------------------------|-------------------|-------------------|--------------------------------------|---|--|
| | 铅 Lead (Pb) | 汞 Mercury (Hg) | 镉 Cadmium (Cd) | 六价铬 Hexavalent Chromium (Cr (VI)) | 多溴联苯 Poly-brominated biphenyls (PBB) | 多溴二苯醚 Polybrominated diphenyl ethers (PBDE) |
| Electronic PCB, cables | X ¹⁾ | ○ | ○ | ○ | ○ | ○ |
| Display | ○ | ○ | ○ | ○ | ○ | ○ |
| Housing | X ²⁾ | ○ | ○ | ○ | ○ | ○ |
| Base, metal, accessories | X ²⁾ | ○ | ○ | ○ | ○ | ○ |

本表格依据SJ/T 11364的规定编制。
 This table is made according to SJ/T 11364.

11 Appendix



O: 表示该有害物质在该部件所有均质材料中的含量均在GB/T 26572规定的限量要求以下。
Indicates that the content of the harmful substance in all homogeneous materials of the component part is below the limit as defined in GB/T 26572.)

X: 表示该有害物质至少在该部件的某一均质材料中的含量超出GB/T 26572规定的限量要求。(企业可在此处, 根据实际情况对上表打“X”的技术原因进行进一步说明。)
Indicates that the content of the harmful substance in at least one homogeneous material of the component part exceeds the limit as defined in GB/T 26572. (Contact the manufacturer for further technical information according to the actual situation.)

1) Contains parts in compliance with exemptions 6c, 7c.I, 7c.II and 37 of 2011/65/EU RoHS.

2) Contains parts in compliance with exemptions 6a, 6b and 6c of 2011/65/EU RoHS.

Apart from the exemptions given in this table, none of the substances listed above have been intentionally added to the product or metallic coatings.

Sigma Laborzentrifugen GmbH

An der Unteren Söse 50
37520 Osterode
Germany

Osterode, 20/11/2017



General Manager

12 Index

A

| | |
|--|------------|
| Acceleration time | |
| - see also the softstart and softstop function | |
| | 35 |
| Accessories, cleaning and care..... | 43 |
| Acid..... | 20, 42, 44 |
| Adapters | 43 |
| Alkaline solutions | 20, 42, 44 |
| Ambient conditions..... | 53 |
| Ambient temperature | 53 |
| Anodised coating | 43 |
| Application examples | 13 |
| Autoclaving | 46 |

C

| | |
|--|--------|
| Calling up stored programs | 37 |
| Capacity..... | 51, 52 |
| Capillary tubes | 29 |
| CE mark in compliance with the directive 2006/42/EC | 15 |
| Centrifugation of infectious, toxic, radioactive, or pathogenic substances..... | 19 |
| Centrifugation principle | 13 |
| Centrifugation with low capacity | 30 |
| Centrifuge cannot be started..... | 38 |
| Centrifuge decelerates during operation | 38 |
| Centrifuge, cleaning and care | 42 |
| Changes in colour | 46 |
| Changes in structure..... | 46 |
| Changing the runtime during centrifugation | 33 |
| Changing the speed/RCF value during centrifugation..... | 32 |
| Chemical and biological safety..... | 19 |
| Chemical resistance of plastic..... | 44 |
| China RoHS 2 – Declaration of conformity. | 65 |
| Cleaning agents..... | 45 |
| Cleaning the bores of angle rotors | 43 |
| Cleaning the centrifuge | 42 |
| Closing the lid | 18, 27 |
| CO ₂ equivalent..... | 51, 52 |
| Communication error | 40 |
| Condensation..... | 25 |

| | |
|------------------------------------|----------------------------|
| Condenser, cleaning and care | 43 |
| Contamination..... | 19, 43 |
| Continuous heat resistance..... | 45 |
| Continuous run | 34 |
| Copyright | 10 |
| Corrosion | 18, 21, 30, 42, 43, 44, 45 |
| Cost estimate..... | 48 |
| Cracking | 43 |
| Cracks | 44 |
| Customer-provided fuses | 26 |

D

| | |
|--|--------|
| Damage of the surface..... | 44 |
| Dangerous goods..... | 20 |
| Dangerous materials..... | 45 |
| Date of manufacture | 12 |
| Deceleration time | |
| - see also the softstart and softstop function | |
| | 35 |
| Declaration of conformity | 10, 61 |
| Declaration of conformity – China RoHS 2. | 65 |
| Declaration of decontamination..... | 48, 50 |
| Decontamination agent..... | 43, 45 |
| Deformation of tubes..... | 46 |
| Density..... | 12, 20 |
| Different service life of rotors and accessories | |
| | 21, 56 |
| Dimensions | 23 |
| Direct hazard to the life and health..... | 16 |
| Directive 2002/96/EC | 50 |
| Disinfectants | 45 |
| Disinfection of the rotor chamber and accessories | 45 |
| Disposal of the centrifuge..... | 50 |
| Disposal of the packaging | 50 |
| Documentation..... | 10 |

E

| | |
|------------------------------------|--------|
| Earth conductor check | 22 |
| EC declaration of conformity | 10, 61 |
| EEPROM error..... | 40 |
| Electrical connection | 51, 52 |
| Electrical safety..... | 18 |

Index

| | | | | |
|--|------------|----------|---|--------|
| Emergency lid release | 39 | L | Layout of the centrifuge..... | 11 |
| Error correction | 38 | | Leaks | 46 |
| Error messages | 38 | | Lid cannot be opened | 38 |
| Explanation of the symbols and notes..... | 16 | | Lid error | 40 |
| Explosive substances | 19 | | Lid is not closed correctly..... | 38 |
| F | | | Lid lock device | 21 |
| Fatal error | 38 | | Lid lock has not released | 38 |
| Filling quantity (refrigerant) | 51, 52 | | Lid lock is not closed correctly..... | 38 |
| Fire preventions | 19 | | Lid seal sticks | 38 |
| Form for the return of defective parts | 48 | M | | |
| Functional and operating elements | 11 | | Mains power switch off..... | 38 |
| G | | | Mains voltage..... | 18 |
| General conditions | 9 | | Maintenance | 42 |
| General malfunctions | 38 | | Malfunction | 38 |
| Glass breakage..... | 45 | | Malfunctions and error correction..... | 38 |
| Glass particles | 45 | | Manual release of the lid lock..... | 39 |
| Gravitational field | 29, 51, 52 | | Manufacturer..... | 51, 52 |
| Grease for load-bearing bolts..... | 42 | | Marking of the unit | 15 |
| H | | | Measures in the event of hazards and accidents | 22 |
| Hazard warnings | 9, 28, 30 | | Mechanical safety | 18 |
| Highly corrosive substances | 18 | | Microhaematocrit rotor | 44 |
| I | | | Mode of operation | 13 |
| Imbalance | 30 | | Motor error | 40 |
| Imbalance error..... | 40 | | Motor shaft..... | 42 |
| Importance of the operating manual..... | 9 | N | | |
| Important information | 16 | | Name plate | 12 |
| Infectious substances | 45 | | No indication on the display | 38 |
| Inflammable substances | 19 | | No power in the mains supply | 38 |
| Informal safety instructions | 17 | | Noise level | 51, 52 |
| Initial start-up | 27 | | Nominal voltage | 12 |
| Input fuse | 51, 52 | | Notes on safety and hazards | 9 |
| Inspection by the manufacturer | 47 | | Notes on transport | 23 |
| Installation of a microhaematocrit rotor | 29 | O | | |
| Installation of a rotor | 28 | | Online download of forms | 49 |
| Installation of accessories | 30 | | Opening the lid..... | 27 |
| Installation of rotors and accessories | 28 | | Operating personnel | 17 |
| Installation site | 25 | | Operating voltage..... | 25 |
| Intended use | 9 | | Operational safety..... | 43 |
| Interrupting a centrifugation run | 32 | | Overseas shipping | 23 |
| Interrupting a deceleration process | 32 | P | | |
| IP code | 51, 52 | | Packaging | 24 |
| K | | | | |
| Kinetic energy | 12, 51, 52 | | | |

| | | | |
|---|------------|---|--------------------|
| Parameter | 29 | Safety devices | 21 |
| Parameter error | 40 | Safety distance | 18, 20, 25 |
| Pathogenic substances | 19, 42, 45 | Safety instructions..... | 9, 28, 30 |
| Performance data | 51, 52 | Safety instructions for centrifugation | 20 |
| Plastic accessories, cleaning and care..... | 44 | Safety of rotors and accessories | 21 |
| Potential hazard to the life and health | 16 | Safety, chemical and biological | 19 |
| Potentially hazardous situation..... | 16 | Safety, electrical | 18 |
| Power consumption | 12, 51, 52 | Safety, mechanical..... | 18 |
| Power cord is not plugged in..... | 38 | Safety-conscious work | 17 |
| Power supply | 25 | Saving the current settings..... | 37 |
| Precooling program "Precool" | 34, 37 | Scope of supply | 10 |
| Pressure (refrigerant)..... | 51, 52 | Serial number | 12, 41, 47 |
| Pressure marks..... | 44 | Service..... | 47 |
| Prevention of accidents..... | 9 | Service contact | 41 |
| Problem description | 48 | Service life | 42 |
| Process error | 40 | Service life of rotors and accessories... 21, 56 | |
| Programm | 37 | Service life of the accessories..... | 46 |
| Protection class | 25, 51, 52 | Service work | 47 |
| Q | | Set-up and connection | 25 |
| Quick run | 33 | Short run..... | 33 |
| R | | Softstart and softstop function..... | 35 |
| Radioactive substances | 19, 42 | Solvents..... | 20, 42, 44 |
| Radius | 14 | Spare part enquiries..... | 41 |
| RCF | 32 | Speed | 12, 14, 32, 51, 52 |
| Refrigerant..... | 51, 52 | Speed-gravitational-field-diagram | 55 |
| Refrigerant data | 12, 51, 52 | Speedometer error..... | 40 |
| Relative centrifugal force (RCF)..... | 14, 32 | Spincontrol Basic | 31 |
| Removal of a rotor | 28 | Standards and regulations | 10 |
| Remove glass particles and metal dust from the rotor chamber | 45 | Standstill monitoring system | 22 |
| Responsibility of the operator..... | 17 | Starting a centrifugation run..... | 32 |
| Return of centrifuges, spare parts, or accessories | 48 | Sterilisation of the rotor chamber and accessories | 45 |
| Return of defective parts | 48 | Storage and transport | 23 |
| Risk of electrical shock..... | 18 | Storage conditions | 23 |
| Rotor chamber | 42 | Stress-corrosion | |
| Rotor radii | 54 | see | |
| Rotor wrench | 28 | corrosion | 44 |
| Rotors and accessories with a different service life | 21, 56 | Structural changes | 19 |
| Rotors, cleaning and care | 44 | Supply voltage | 25 |
| Runtime | 33 | Switching the centrifuge off | 37 |
| S | | System check | 22 |
| Safety area | 20 | System error | 40 |
| | | T | |
| | | Table of error codes..... | 40 |

Index

| | | | |
|---|--------|----------------------------------|------------|
| Table of rotors and accessories with a different service life | 21, 56 | Type..... | 12, 51, 52 |
| Technical data | 51, 52 | Type of connection..... | 25 |
| Technical documentation | 53 | Type of the centrifuge | 41, 47 |
| Temperature | 34 | U | |
| Temperature error..... | 40 | Units of protection class I..... | 25 |
| Temperature inside the rotor chamber | 22 | User interface | 31 |
| Temperature monitoring system..... | 22 | UV radiation | 25, 42 |
| Temperature range | 51, 52 | V | |
| Temperature value cannot be reached..... | 38 | Vents | 25 |
| Thermal stress | 42 | W | |
| Time range..... | 51, 52 | Warranty and liability..... | 9 |
| Toxic substances | 19, 42 | Wear..... | 47 |
| Transport safety device..... | 24 | Weight | 23 |