



# RVC 2-33 CDplus

## with infrared heating

part no. 100244



Rotational Vacuum  
Concentrator

# Operating Manual

Please retain for later use!



In case of inquiries, please state the following numbers:

Order number:

Serial number:

© Copyright by  
Martin Christ Gefriertrocknungsanlagen GmbH  
An der Unteren Söse 50  
37520 Osterode am Harz  
Germany  
Tel.: +49 (0) 5522 / 5007-0  
Fax: +49 (0) 5522 / 5007-12  
Web: [www.martinchrist.de](http://www.martinchrist.de)  
E-mail: [info@martinchrist.de](mailto:info@martinchrist.de)



---

<b>1</b>	<b>General information</b>	<b>9</b>
1.1	Importance of the operating manual	9
1.2	Intended use	9
1.3	Warranty and liability	9
1.4	Copyright	10
1.5	Explanation of symbols	10
1.6	Standards and regulations	10
1.7	Scope of supply	10
<b>2</b>	<b>Layout and mode of operation</b>	<b>11</b>
2.1	Layout of the RVC	11
2.1.1	Functional and operating elements	11
2.1.2	Name plate	12
2.2	Mode of operation	13
2.2.1	Principle of the rotational vacuum concentration	13
2.2.1.1	Advantages of the rotational vacuum concentration	14
2.2.1.2	Examples of use	15
<b>3</b>	<b>Safety</b>	<b>16</b>
3.1	Marking of the unit	16
3.2	Explanation of the symbols and notes	17
3.3	Responsibility of the operator	18
3.4	Operating personnel	18
3.5	Informal safety instructions	18
3.6	Safety instructions	19
3.6.1	Electrical safety	19
3.6.2	Mechanical safety	19
3.6.3	Fire prevention	20
3.6.4	Thermal safety	20
3.6.5	Chemical and biological safety	20
3.6.6	Safety instructions for evaporation	21
3.7	Safety devices	22
3.7.1	Lid lock device	22
3.7.2	System check	22
3.7.3	Power failure safety	22
3.7.4	Earth conductor check	22
3.8	Procedures in the event of hazards and accidents	23
3.9	Remaining hazards	23
<b>4</b>	<b>Storage and transport</b>	<b>24</b>
4.1	Storage conditions	24
4.2	Dimensions and weight	24
4.3	Packaging	24
4.4	Transport safety device	25
4.5	On-site transport	25

## Table of contents

<b>5</b>	<b>Set-up and connection</b>	<b>26</b>
5.1	Installation site	26
5.2	Power supply	26
5.2.1	Type of connection	26
5.2.2	Customer-provided fuses	26
5.3	Aeration and micro injection valve (Valve block)	27
5.4	Vacuum connections	28
5.5	Option: Pressure control valve and vacuum sensor	29
5.6	Connection of a vacuum pump and/or a cooling trap	30
5.6.1	Withdrawal of the vapours by a vacuum pump	30
5.6.2	Condensation of the vapours upstream of the vacuum pump in a cooling trap	31
5.6.2.1	Option: Remote control of the cooling trap via RVC	32
<b>6</b>	<b>Operation</b>	<b>33</b>
6.1	Initial start-up	33
6.2	Switching the RVC on	33
6.3	Opening and closing the lid	33
6.4	Installation of rotors and accessories	34
6.4.1	Installation of angle rotors	34
6.4.2	Installation of swing-out rotors	35
6.4.3	Installation of accessories	35
6.4.3.1	Tubes	36
6.4.3.2	Rotor blocks	37
6.4.3.3	Buckets	37
6.5	CDplus control system	39
6.5.1	User interface	39
6.5.2	Mode	42
6.5.3	Main menu	44
6.5.3.1	Changing the set values for the manual mode	44
6.5.3.2	Program administration	46
6.5.3.3	Special functions	49
6.5.3.4	Process and equipment information	50
6.5.3.5	Options	51
<b>7</b>	<b>Malfunctions and error correction</b>	<b>54</b>
7.1	General malfunctions	54
7.1.1	Error messages	54
7.1.2	Process messages	55
7.1.3	System messages	56
7.1.4	Emergency lid release	56
7.1.5	Small flange connections	58
7.2	Service contact	59

**Table of contents**

---

<b>8</b>	<b>Maintenance and service</b> .....	<b>60</b>
8.1	Maintenance .....	60
8.1.1	Rotational vacuum concentrator .....	60
8.1.2	Rotor chamber .....	61
8.1.3	Accessories .....	65
8.1.3.1	Aluminium accessories .....	66
8.1.4	Glass breakage .....	66
8.2	Disinfection of the rotor chamber and accessories.....	67
8.3	Autoclaving.....	67
8.4	Service .....	68
8.5	Return of defective parts.....	68
<b>9</b>	<b>Disposal</b> .....	<b>70</b>
9.1	Disposal of the RVC.....	70
9.2	Disposal of the packaging.....	70
<b>10</b>	<b>Technical data</b> .....	<b>71</b>
10.1	Ambient conditions .....	72
10.2	Technical documentation .....	72
<b>11</b>	<b>Appendix</b> .....	<b>73</b>
11.1	Mathematical relations .....	73
11.2	Rotor program.....	74
11.3	Overview of evaporation times (RVC 2-33 CDplus with infrared heating).....	75
11.4	Brief operating instructions .....	77
11.5	EC declaration of conformity .....	79
11.6	Declaration of conformity – China RoHS 2.....	81
<b>12</b>	<b>Glossary</b> .....	<b>83</b>
<b>13</b>	<b>Index</b> .....	<b>85</b>

**Table of contents**

---



## **1 General information**

### **1.1 Importance of the operating manual**

A fundamental requirement for the safe and trouble-free operation of the unit is to be familiar with the fundamental safety instructions and all possible hazards.

The operating manual includes important information concerning the safe operation of the rotational vacuum concentrator (RVC).

This operating manual, and in particular the notes on safety and hazards, must be observed by all persons operating the unit.

In addition, the local rules and regulations for the prevention of accidents must be complied with.

### **1.2 Intended use**

CHRIST rotational vacuum concentrators are solely intended for evaporation under rotation, e.g. for the following tasks:

- concentration of DNA/RNA, proteins etc.
- preparation of samples for HPLC/thin layer chromatography, gas chromatography, mass-spectrometry
- isolation and synthesis of organic substances
- high-throughput-screening (HTS)
- general in-lab evaporation.

Any other use beyond this area of application is regarded as improper use. Martin Christ Gefriertrocknungsanlagen GmbH cannot be held liable for any damage resulting from such improper use.

The intended use also includes:

- observation of all the notes and instructions included in the operating manual
- compliance with the inspection and maintenance instructions
- prohibition of any type of extensions to, or conversions of, the unit.

### **1.3 Warranty and liability**

The warranty and liability are subject to our "General Terms and Conditions" that were distributed to the operator upon the conclusion of the contract.

Warranty and liability claims are excluded if they are due to one or several of the following reasons:

- improper use
- non-compliance with the safety instructions and hazard warnings in the operating manual
- improper installation, start-up, operation, and maintenance of the RVC.

## 1 General information

---

### 1.4 Copyright

The copyright concerning the operating manual remains with Martin Christ Gefriertrocknungsanlagen GmbH.

The operating manual is solely intended for the operator and their personnel. It includes instructions and information that may not be

- duplicated,
- distributed, or
- communicated in any other way neither in full nor in parts.

Non-compliance may be prosecuted under criminal law.

### 1.5 Explanation of symbols

In this operating manual, the specialist terms that are explained in the glossary (see chapter 12 - "Glossary") are marked by an arrow and printed in italics (e.g. → *safety pressure*).

### 1.6 Standards and regulations

EC-Declaration of conformity (see appendix)

### 1.7 Scope of supply

**The scope of supply comprises:**

- 1 hexagon socket wrench, size 5
- 1 L-key Torx® TX15
- 1 screwdriver Torx® TX8
- 1 operating manual

#### **Accessories and commissioning**

According to your order, our order confirmation, and our delivery note.

## 2 Layout and mode of operation

### 2.1 Layout of the RVC

#### 2.1.1 Functional and operating elements

- 1 Lid
- 2 Rotor chamber
- 3 Control panel (see chapter 6.5.1 - "User interface")
- 4 Lid lock device
- 5 Rotor shaft
- 6 Mains power switch
- 7 Electrical vacuum sensor connection
- 8 Option: Serial Interface RS 232
- 9 Option: Serial Interface Remote
- 10 Name plate (see chapter 2.1.2 - "Name plate")
- 11 Power supply connection of the vacuum pump
- 12 Power supply connection of the pressure control valve
- 13 Valve block (see chapter 5.3 - "Aeration and micro injection valve (Valve block)")
- 14 Vacuum connection
- 15 Equipotential bonding screw
- 16 Mains connection and mains fuse protection
- 17 Power supply connection of the stop valve



Fig. 1: Total view of the RVC

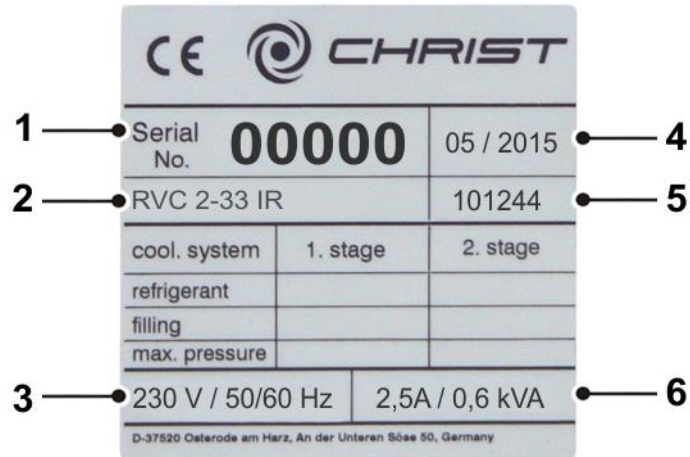

Fig. 1: Rear view of the RVC

## 2 Layout and mode of operation

### 2.1.2 Name plate

- 1 Serial number
- 2 Type
- 3 Nominal voltage
- 4 Year of manufacture (month/year)
- 5 Part number
- 6 Rated current / apparent power



CE  CHRIST		
1 —●	Serial No. <b>00000</b>	05 / 2015 ●— 4
2 —●	RVC 2-33 IR	101244 ●— 5
	cool. system	1. stage    2. stage
	refrigerant	
	filling	
	max. pressure	
3 —●	230 V / 50/60 Hz	2,5A / 0,6 kVA ●— 6
<small>D-37520 Osterode am Harz, An der Unteren Söbe 50, Germany</small>		

Fig. 2: Example of a name plate

## 2.2 Mode of operation

### 2.2.1 Principle of the rotational vacuum concentration

This method is used for the particularly quick and gentle evaporation, drying, purification, and concentration of samples.

Rotational vacuum concentration is an alternative to rotary evaporators that use high temperatures and operate nearly at normal pressure. Because of the vacuum, the sample boils at low temperatures, and water as well as organic solvents can be evaporated in a particularly gentle manner. Due to the fact that the sample rotates like in a centrifuge, the → *Boiling retardation* is prevented so efficiently that low pressure can be used. As a result, temperature-sensitive samples can be concentrated by evaporation without being damaged.

The solvent can be collected in a cooling trap and disposed of immediately if desired.

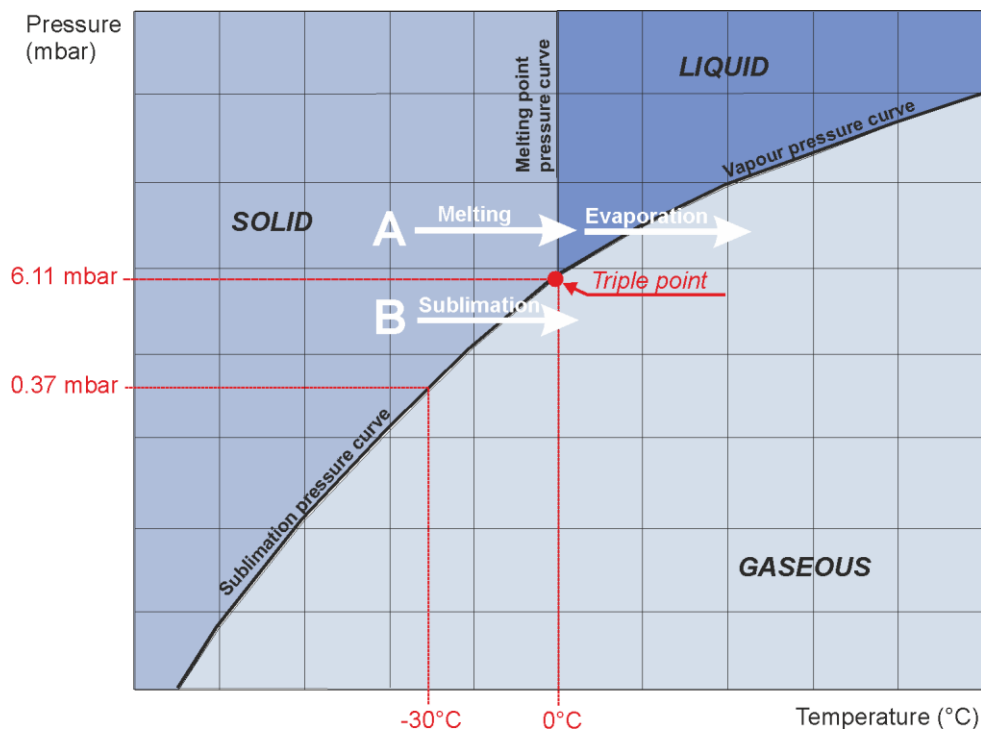

Fig. 3: Vapour pressure curve for ice and water

## 2 Layout and mode of operation

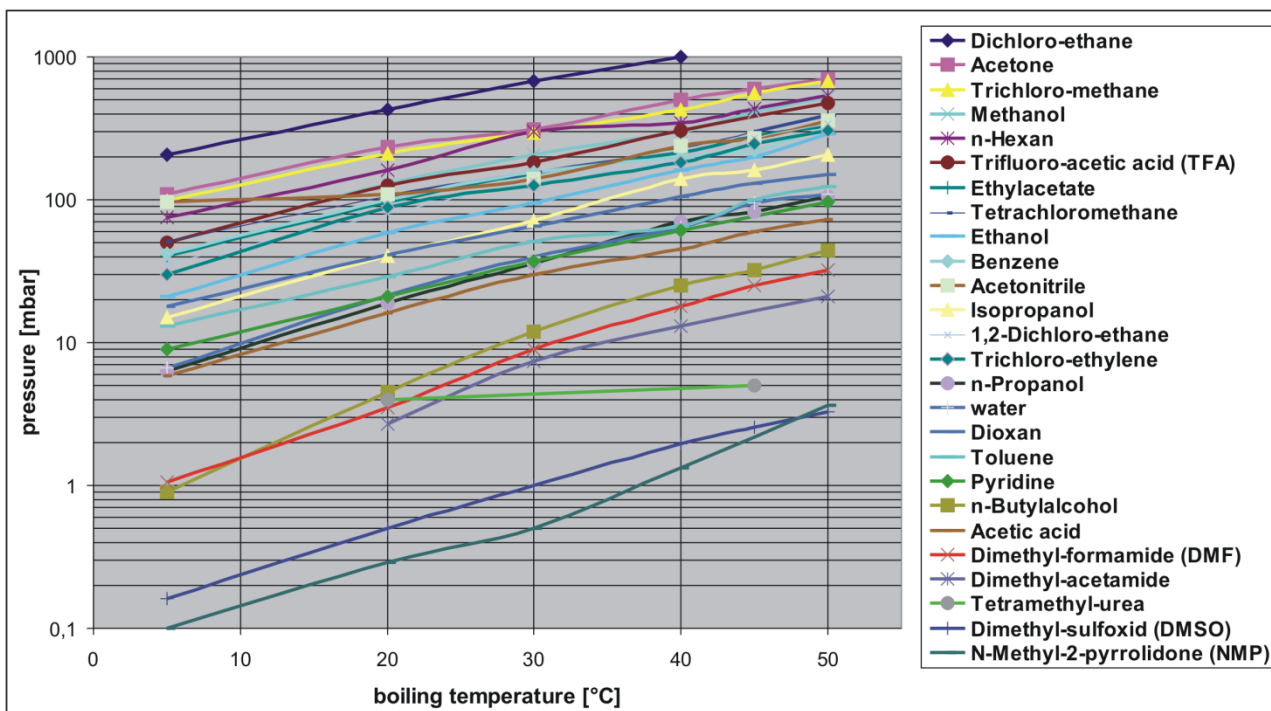

Fig. 4: Vapour pressure curves of commonly used organic solvents

### 2.2.1.1 Advantages of the rotational vacuum concentration

- No foaming of the samples, minimum loss.
- Several samples can be dried simultaneously.
- Concentration of the sample on the bottom of the vessel. This is particularly advantageous for small volumes or dilute solutions.
- Suitable for drying aqueous and solvent-containing samples.
- For volumes < 1 ml up to > 3 l.
- Reproducible drying processes thanks to controlled process parameters, such as the rotor chamber temperature (energy input for the evaporation) and vacuum (up to the automatic adjustment of the optimum operating pressure – depending on the pump systems).
- Easy and safe solvent recovery.

**2.2.1.2 Examples of use**











- DNA/RNA (mainly water, ethanol, or methanol as solvent)
- Oligo-synthesis, peptides
- PCR (polymer chain reaction)
- HPLC (mainly water/acetonitrile as solvent)
- Isolation/synthesis of organic substances
- Storage and handling of substances (substance libraries)
- Combinational chemistry
- High-throughput-screening (HTS)
- Analysis of food and environmental samples, toxicology
- Forensic applications
- General laboratory evaporation

### 3 Safety

## 3 Safety

### 3.1 Marking of the unit

The following symbols are used for Christ RVC:

	Dangerous voltage	<b>I</b>	On (Power)
	Hot surface	<b>0</b>	Off (Power)
	Caution! Risk of bruising		Name plate (see chapter 2.1.2 - "Name plate")
	Attention, consult the operating manual	<b>CE</b>	CE mark in compliance with the directive 2006/42/EC
	Protective earth (ground)		Unplug the mains plug
	Earth (ground)		China RoHS 2 mark (only for China)
	Arrow indicating the direction of rotation		

**i**  
NOTE

Safety indications on the rotational vacuum concentrator must be kept readable at all times. If necessary, they must be replaced.

**i**  
NOTE

Not all of the symbols/labels are used for this RVC type.



### 3.2 Explanation of the symbols and notes

This operating manual uses the following names and symbols to indicate hazards:



**DANGER**

This symbol stands for a **direct** hazard to the life and health of persons. Non-observance of these symbols **causes** serious health problems up to life-endangering injuries.



**DANGER**

This symbol stands for a **direct** hazard to the life and health of persons due to electrical voltage. Non-observance of these symbols **causes** serious health problems up to life-endangering injuries.



**WARNING**

This symbol stands for a **potential** hazard to the life and health of persons. Non-observance of these symbols **can** cause serious health problems up to life-endangering injuries.



**CAUTION**

This symbol indicates a potentially hazardous situation. Non-observance of these notes can cause minor injuries or damage to property.



**NOTE**

This symbol indicates important information.

## 3 Safety

---

### 3.3 Responsibility of the operator

The operator is responsible for authorising only qualified personnel to work on the RVC (see chapter 3.4 - "Operating personnel").

The areas of responsibility of the personnel concerning the operation, maintenance, and care of the unit must be clearly defined.

The safety-conscious work of the personnel in compliance with the operating manual and the relevant EC and national health and safety regulations as well as with the accident prevention regulations must be checked at regular intervals (e.g. every month).

The RVC must be maintained regularly (see chapter 8 - "Maintenance and service").

### 3.4 Operating personnel

Persons operating the unit must

- be familiar with the fundamental regulations concerning workplace safety and accident prevention
- have read and understood this operating manual (and in particular the safety sections and warning notes) and confirmed this with their signature.

### 3.5 Informal safety instructions

This operating manual is part of the product.

- The operating manual must be kept at the location of use of the RVC. Ensure that it is accessible at all times.
- The operating manual must be handed over to any subsequent owner or operator of the RVC.
- Any changes made must be added to the operating manual.
- In addition to the operating manual, the general and local rules and regulations concerning the prevention of accidents and the protection of the environment must also be supplied.
- Safety and danger indications on the RVC must be kept readable at all times. If necessary, they must be replaced.

## 3.6 Safety instructions

### 3.6.1 Electrical safety

CHRIST rotational vacuum concentrators are units of safety class I. The RVCs are equipped with a three-wire power cord and a 230 VAC safety plug with earthing contact. Please comply with the following points in order to preserve this safety feature:



**DANGER**

- Ensure that the local mains voltage matches the nominal voltage that is stated on the name plate.
- Do not place any dangerous material, e.g. glass vessels containing liquid substances, within the safety area of 30 cm around the RVC. Spilled liquids may get into the RVC and damage the electrical or mechanical components.
- Work on the power supply system must only be performed by certified electricians.
- Inspect the electrical equipment of the unit regularly. Defects such as loose or burnt cables must be eliminated immediately.

### 3.6.2 Mechanical safety

In order to ensure the safe operation of the RVC, please comply with the following points:



**WARNING**

- Do not use the RVC if it was installed incorrectly.
- Do not use the RVC without panels.
- Do not use the RVC with accessories that show signs of damage.
- Only use the RVC with accessories that have been approved by the manufacturer. In case of doubt, contact the manufacturer (see chapter 7.2 - "Service contact").
- Do not hold your fingers between the lid and the housing when closing the lid. Risk of crushing!
- Do not hit or move the RVC during its operation.
- Do not lean against or rest on the RVC during its operation.
- Check the RVC and accessories before every start-up for any visible signs of damage.
- Do not evaporate any substances that could damage the material of the rotors, rotor chamber or lid of the RVC in any way. Highly corrosive substances (e.g. hydrogen chloride HCl) damage the material and affect the mechanical strength of the rotors and accessories.
- Stop the RVC immediately in the event of a malfunction. Eliminate the malfunction or contact the after-sales service of Martin Christ Gefriertrocknungsanlagen GmbH (see chapter 7 - "Malfunctions and error correction").
- Ensure that all repairs are performed only by authorised and specialised personnel (see chapter 7.2 - "Service contact").

### 3 Safety

#### 3.6.3 Fire prevention

Fuses protect certain electrical circuits within the RVC against over-current conditions.



GEFAHR

- Always use fuses of the same type and rating.
- Do not evaporate explosive or inflammable substances.
- Do not use the RVC within hazardous locations where there is a risk of explosion.

#### 3.6.4 Thermal safety

During the evaporation process, the housing, lid and interior of the RVC can reach surface temperatures of more than +50°C.



DANGER

- Open and close the lid at the heat-insulated handle!
- Ensure that no limbs come into contact with hot unit parts or accessories. Danger of burns!
- Wear heat-resistant gloves when inserting or removing the rotors.

#### 3.6.5 Chemical and biological safety

If pathogenic, toxic, or radioactive samples are intended to be evaporated, it is in the responsibility of the user to ensure that all necessary safety regulations, guidelines, precautions, and practices are adhered to accordingly.



DANGER

- Infectious, toxic, pathogenic, and radioactive substances must be evaporated in suitable accessories. Take suitable precautions for your own safety!
- Do not evaporate corrosive products (especially substances containing acids) without special protective measures and devices such as, for example, a cooling trap for the protection of the vacuum pump. Contact the manufacturer (see chapter 7.2 - "Service contact").
- Special caution is necessary when handling azides, as a dangerous explosive develops in combination with copper or nonferrous metals! It is absolutely necessary to contact the manufacturer (see chapter 7.2 - "Service contact").
- Keep informed about local measures to avoid harmful emissions (depending on the substances to be evaporated).
- As personal protective equipment, safety gloves are required for the use of the RVC.  
The materials to be evaporated may, however, require additional special safety measures (e.g. drying of infectious, toxic, radioactive, or pathogenic substances)

### 3.6.6 Safety instructions for evaporation

The following instructions must be observed prior to every evaporation process:



**WARNING**

- Ensure that the RVC was set up and connected properly (see chapter 5 - "Set-up and connection").
- Maintain a safety distance of at least 30 cm (12 inches) around the RVC.
- Do not store any dangerous goods in the safety area of the RVC.
- Do not stay in the safety area longer than what is absolutely necessary for the operation of the RVC.
- Only use accessories that have been approved by the manufacturer (except for commercial vessels made of glass or synthetic materials). We explicitly warn against the use of equipment of poor quality. Breaking glass or bursting vessels can cause dangerous imbalances.
- Observe the instructions on the installation of accessories (see chapter 6.4.3 - "Installation of accessories").

## **3 Safety**

---

### **3.7 Safety devices**

#### **3.7.1 Lid lock device**

The RVC can only be started when the lid is properly closed. The lid can only be opened when the rotor has stopped. If the lid is open, the RVC cannot be started.

#### **3.7.2 System check**

An internal system check monitors the data transfer and sensor signals with regard to plausibility. Errors are detected by continuous self-monitoring of the system. Error messages are displayed in the process & equipment info menu (see chapter 6.5.3.4 - "Process and equipment information" or chapter 7.1.1 - "Error messages").

#### **3.7.3 Power failure safety**

The unit stores the current process parameters cyclically. In the event of a power failure, the electromagnetic stop valve will close automatically, the rotor chamber will be aerated by the aeration valve and the rotor decelerates brakeless. After the restart of the power supply, the evaporation process continues with the last stored parameters.

#### **3.7.4 Earth conductor check**

For the earth conductor check, there is an equipotential bonding screw on the rear panel of the RVC. An earth conductor check can be carried out with the aid of a suitable measuring instrument.

### 3.8 Procedures in the event of hazards and accidents



**DANGER**

#### **Fire:**

- A fire in the electrical control system must be extinguished with a CO<sub>2</sub> fire extinguisher!
- Burning oil must be extinguished with a CO<sub>2</sub> fire extinguisher or powder fire extinguisher!

#### **Hazardous electrical incident:**

- Set the mains power switch of the control system to the "0" position in order to interrupt the power supply completely.

#### **Burns:**

- Small-area burns (e.g. finger) should be cooled immediately with lukewarm water for approximately 2 minutes.
- Large-area burns should not be cooled because of the resulting risk of hypothermia.
- Cover the burns loosely and in a sterile manner (e.g. with a sterile dressing).
- Cover the injured person with a blanket.

**IF IN DOUBT, CALL THE EMERGENCY PHYSICIAN (AMBULANCE)!**

### 3.9 Remaining hazards

All Christ rotational vacuum concentrators were built state-of-the-art and according to the accepted safety rules. However, danger to life and limb of the operator, or of third parties, or impairments of the units or other material assets cannot be completely excluded when the units are being used.

- Use the RVC only for the purpose that it was originally intended for (see chapter 1.2 - "Intended use").
- Use the RVC only if it is in a perfect running state.
- Immediately eliminate any problems that can affect safety.

## 4 Storage and transport

# 4 Storage and transport

### 4.1 Storage conditions

In order to ensure the protection against mechanical and climatic influences, the guidelines of the German Federal Association for Wooden Packages, Pallets, and Export Packaging (Bundesverband Holzpackmittel, Paletten, Exportverpackung e.V.), the so-called HPE packaging guidelines, must be applied when packing and storing the RVC.

The storage must be:

- dust-free
- dry
- free from excessive temperature fluctuations
- free from mechanical load.

### 4.2 Dimensions and weight

Values for the RVC without a vacuum pump:

	RVC 2-33 IR
Height:	325 mm
Height with open lid:	715 mm
Width:	550 mm
Depth):	520 mm + 20 mm vacuum connection
Weight:	approx. 49 kg

### 4.3 Packaging

The RVC is packaged in a cardboard box or in a wooden crate, depending on the scope of supply.

- After opening the packaging, take out the box containing the accessories.
- Remove the packaging material.
- Lift the RVC upwards and out of the crate/cardboard box. When lifting the unit, always reach under it from the side.



**CAUTION**

The **RVC 2-33 IR** weighs approx. 49 kg!



#### 4.4 Transport safety device

The following transport safety devices must be removed prior to start-up:

- The polystyrene element that covers the valve block at the back of the RVC must be removed.
- Remove the layers of paper between the lid and rotor chamber; they prevent the lid from getting stuck during the transport.

#### 4.5 On-site transport

- The RVC can be transported by a suitable number of persons who reach under it from the sides.



**CAUTION**

The RVC 2-33 IR weighs approx. 49 kg!

- When lifting the RVC, always reach under it from the side. Do not grab the unit at the plastic control panel (see the illustrations below).

**correct**



*Fig. 5: Lifting the RVC*

**incorrect**



- When setting the unit down, ensure that the feet are upright (see the illustrations below).

**correct**



*Fig. 6: Unit feet*

**incorrect**



- Use suitable packaging for the transport, and if at all possible, the original packaging.

## 5 Set-up and connection

# 5 Set-up and connection

## 5.1 Installation site

Operate the RVC only in closed and dry rooms.

- The table must be stable and have a solid, even tabletop.
- Ensure sufficient ventilation. Do not place any paper, cloth, or similar material behind or under the unit, since otherwise the air circulation will be impaired.
- Keep a safety distance of at least 30 cm from the wall so that the vents in the unit remain fully effective.
- The ambient temperature must be in the range of +10°C to +25°C.
- Do not subject the RVC to thermal stress, e.g. by positioning it near heat generators.
- Avoid direct sunlight (UV radiation).

## 5.2 Power supply

### 5.2.1 Type of connection



**DANGER**

The operating voltage on the name plate must correspond to the local supply voltage!

Christ rotational vacuum concentrators are units of protection class I. Rotational vacuum concentrators of this type have a three-wire power cord with an IEC C13 connector (see chapter 10 - "Technical data").



**NOTE**

The removable power cord must not be replaced with a power cord of inadequate rating!

An equipotential bonding screw is located on the back (see chapter 2.1.1 - "Functional and operating elements"). This equipotential bonding screw can be used to perform an earth conductor check.

### 5.2.2 Customer-provided fuses

Typically, the RVC must be protected with 16 A fuses that are to be provided by the customer.

### 5.3 Aeration and micro injection valve (Valve block)

The rotational vacuum concentrator is equipped with an electromagnetic aeration and injection valve. The rotor chamber is aerated through this valve after the end of the evaporation process (manual and program mode).

In addition, this valve can also inject air. If the vacuum value falls below the preset value, this valve opens briefly to ensure a constant vacuum.

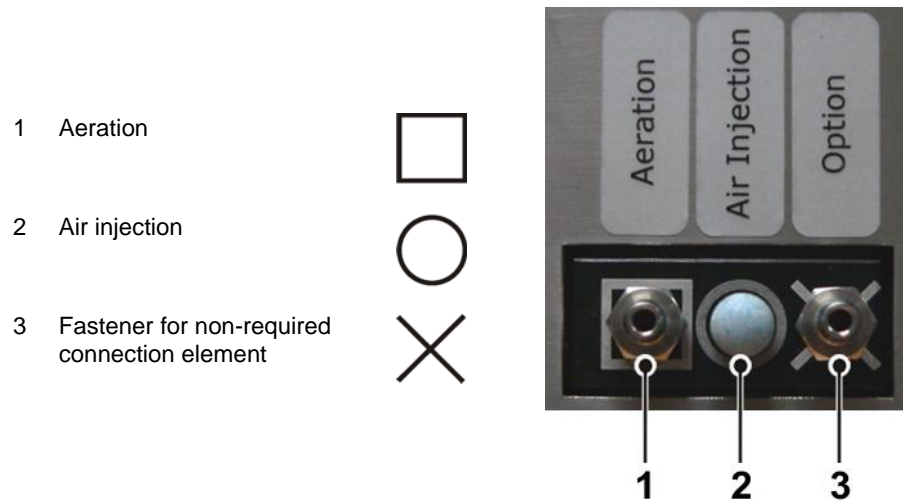

Fig. 7: Valve block



Unpressurised inert gas can also be used for aerating the rotor chamber.

#### Connecting combinations:

1. Connection for aeration and air injection with ambient air (state of delivery)
  - 1 Aeration hose connection
  - 2 Air filter
  - 3 Fastener for non-required connection element; here: hose nozzle
2. Connection for aeration with ambient air and air injection" with inert gas
  - 1 Aeration hose connection
  - 2 Air injection hose nozzle
  - 3 Fastener for non-required connection element; here: air filter

## 5 Set-up and connection

3. Connection for aeration and air injection with inert gas
  - 1 Aeration hose connection
  - 2 Air injection hose nozzle
  - 3 Fastener for non-required connection element; here: air filter



**CAUTION**

If gas (e.g. inert gas) is supplied through the hose nozzle for aeration or for "air injection", the threads of the hose nozzles must be sealed with thread sealant, e.g. Loctite® 542 (Loctite® part number: 54223, bottle with 10ml).

### 5.4 Vacuum connections

The vacuum connection is realised by way of a vacuum hose with standard flange connections, clamping rings, or chains, and centring rings.



**NOTE**

The small flange connections must be installed correctly in order to prevent leaks (see chapter 7.1.5 - "Small flange connections").

- 1 Centring ring
- 2 Clamping ring
- 3 Flange connection

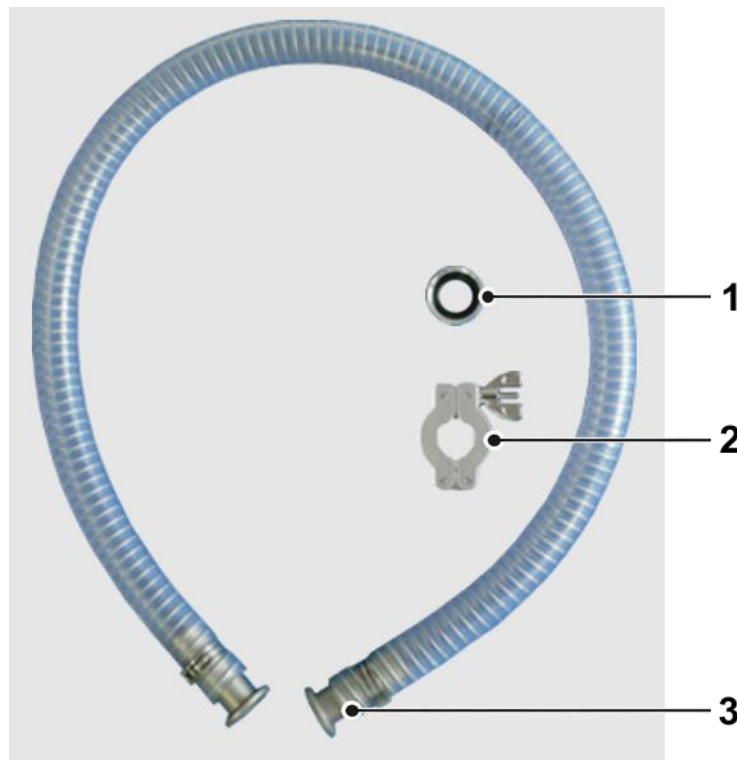

Fig. 1: Connecting pieces for vacuum connection

## 5.5 Option: Pressure control valve and vacuum sensor

If a pressure control valve and a vacuum sensor are used, they must be installed between the rotational vacuum concentrator and the vacuum pump, and they must be connected to the marked IEC C14 connector at the back of the unit (see chapter 2.1.1 - "Functional and operating elements").



Observe the installation direction of the pressure control valve!

- 1 Vacuum sensor
- 2 Pressure control valve



Fig. 8: Installation of the pressure control valve and the vacuum sensor

## 5 Set-up and connection

### 5.6 Connection of a vacuum pump and/or a cooling trap

In order to withdraw and condense the vapours that are formed, the RVC can be connected with further components.

#### 5.6.1 Withdrawal of the vapours by a vacuum pump

The vapours are withdrawn by a vacuum pump, e.g. the vacuum diaphragm pump for chemical applications "MZ 2C" or "MD 4C", followed by condensation in a liquid-cooled emission condenser. This application is suitable for low-boiling samples containing solvents.

The vacuum pump must be connected to the RVC. The connector of the stop valve must be plugged into the socket on the back of the unit (see chapter 2.1.1 - "Functional and operating elements").

**i**  
**NOTE**

The vacuum pump is supplied with power by the unit, but the maximum current for the vacuum pump is limited. It is absolutely essential to refer to the label of the electrical outlet for the vacuum pump (see the following picture)!

If the current requirement of the vacuum pump is higher than the value that is stated on the label, the pump must be supplied separately via an on-site power socket.

- 1 Label indicating the maximum current

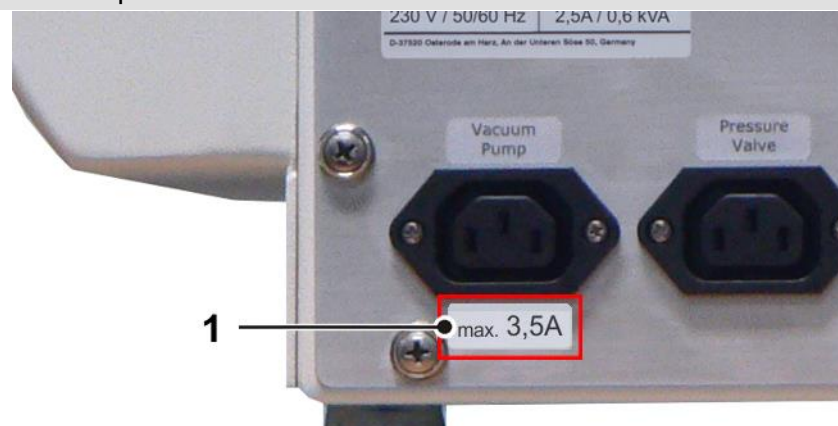

Fig. 9: Indication of the maximum current for the vacuum pump (example)

The connector of the stop valve must be plugged into the socket "Stop valve" on the back of the unit.

- 1 RVC  
2 Vacuum sensor  
3 Stop valve  
4 Vacuum hose  
5 Vacuum pump

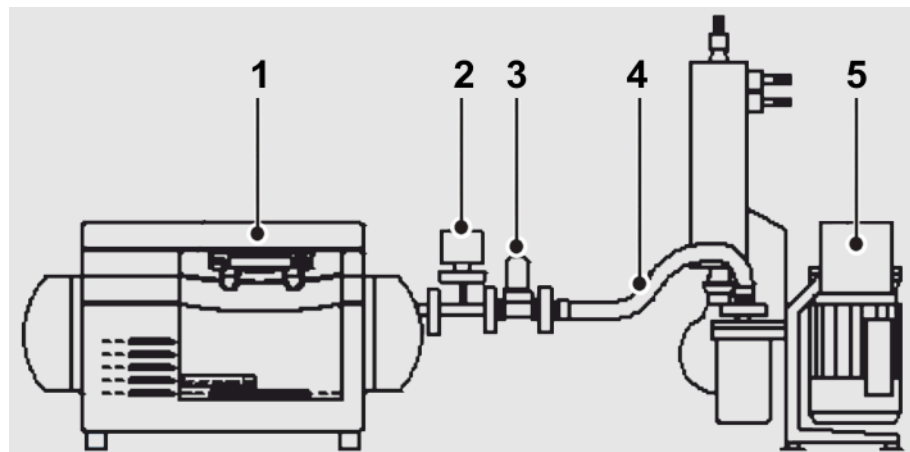

Fig. 10: Combination of the RVC with a vacuum pump and a stop valve

### 5.6.2 Condensation of the vapours upstream of the vacuum pump in a cooling trap

The vapours are condensed upstream of the vacuum pump in a cooling trap, e.g. "CT 02-50" or "CT 04-50".

The application is suitable for water-base, low-boiling samples containing solvents. The RVC, the cooling trap and the vacuum pump must be connected. The connector of the stop valve must be plugged into the socket on the back of the unit.

- 1 RVC
- 2 Vacuum pump
- 3 Cooling trap
- 4 Pressure control valve
- 5 Cover with connecting hoses
- 6 Stop valve
- 7 Vacuum sensor

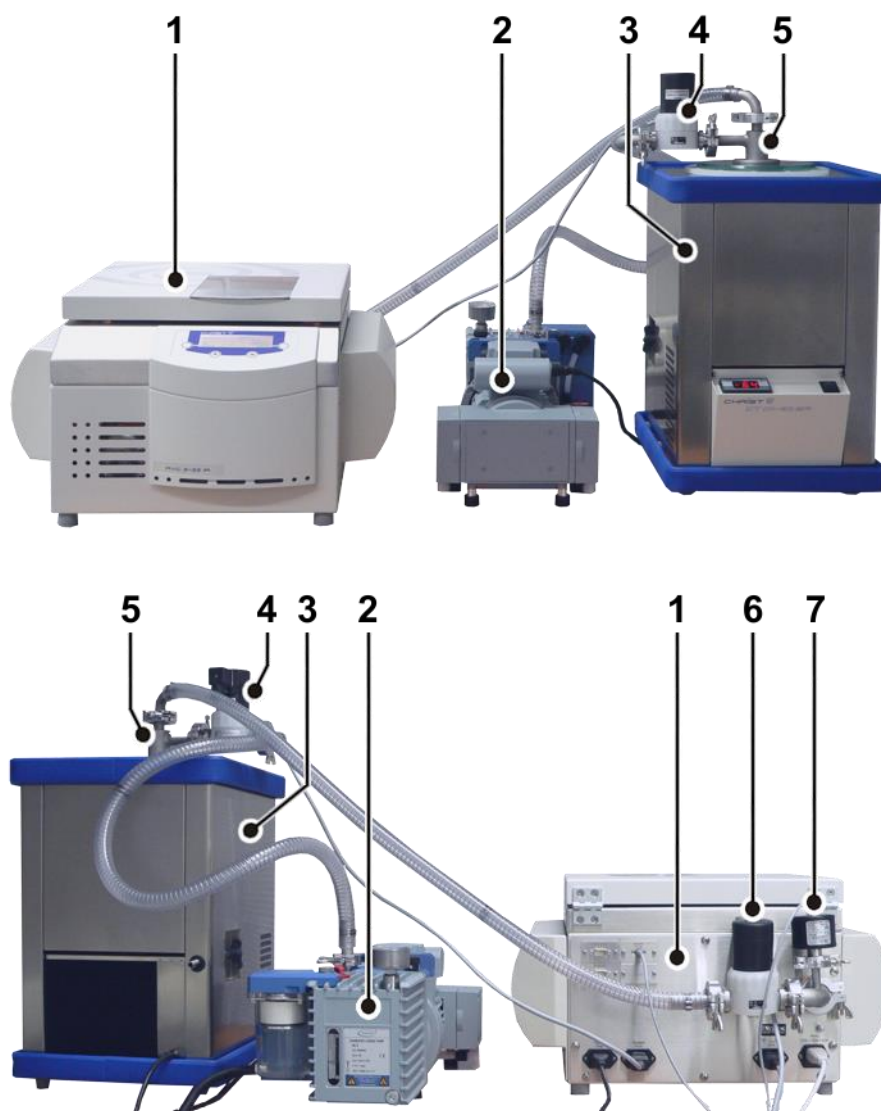

Fig. 11: Combination of the RVC with vacuum pump and cooling trap (front view)

## 5 Set-up and connection

### 5.6.2.1 Option: Remote control of the cooling trap via RVC

If CHRIST freeze dryers are used as a cooling trap, they can be remote-controlled by the rotational vacuum concentrator. In this case, the cooling trap will be automatically activated by the rotational vacuum concentrator during the warm-up and evaporation phase. In the standby mode, the cooling trap will be either switched off or continue operation, depending on the chosen option (chapter 6.5.3.5 - "Options" Settings / Continuous operation coldtrap"). The ice condenser temperature is indicated in the values window of the rotational vacuum concentrator.

The cooling trap must be connected to the rotational vacuum concentrator with the aid of a zero cross cable (part no. 222 000). In addition, the option "Cooling trap control" must be activated (see chapter 6.5.3.5 - "Options").

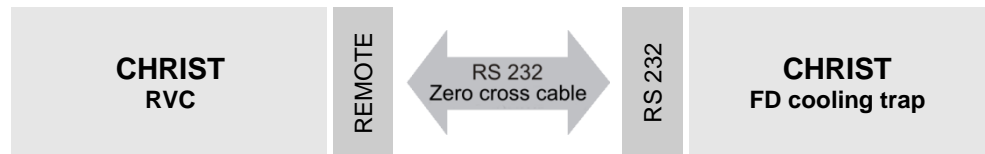



## 6 Operation

### 6.1 Initial start-up



**WARNING**

Before the initial start-up, please ensure that your RVC is properly set up and installed (see chapter 5 - "Set-up and connection")

### 6.2 Switching the RVC on

- Press the mains power switch on the right-hand side of the unit. The CDplus control unit performs a self-test and an initialisation. This may take several seconds.

- Follow the safety instructions and hazard warnings !

### 6.3 Opening and closing the lid

The lid can be opened if the rotor chamber is aerated and if the rotor is at a standstill. The rotational vacuum concentrator cannot be started if the lid is open.

- Select "mode" with the left-hand function key.
- Select "Open lid" with the up and down keys.
- To close, press slightly on the lid until both locks are locked.



**DANGER**

Do not place your fingers between the lid and the housing when closing the lid. Risk of crushing!

## 6 Operation

### 6.4 Installation of rotors and accessories

#### 6.4.1 Installation of angle rotors

- Only use inserts that are suitable for the rotor (see chapter 11.2 - "Rotor program").
- Always load the opposite inserts of the rotors with the same accessories and fill to avoid imbalance.
- Push the loaded rotor onto the rotor shaft until it reaches the stop.



Depending on the version, up to three rotors can be pushed onto the rotor shaft at the same time.

- Follow the safety instructions and hazard warnings (see chapter 3 - "Safety")!

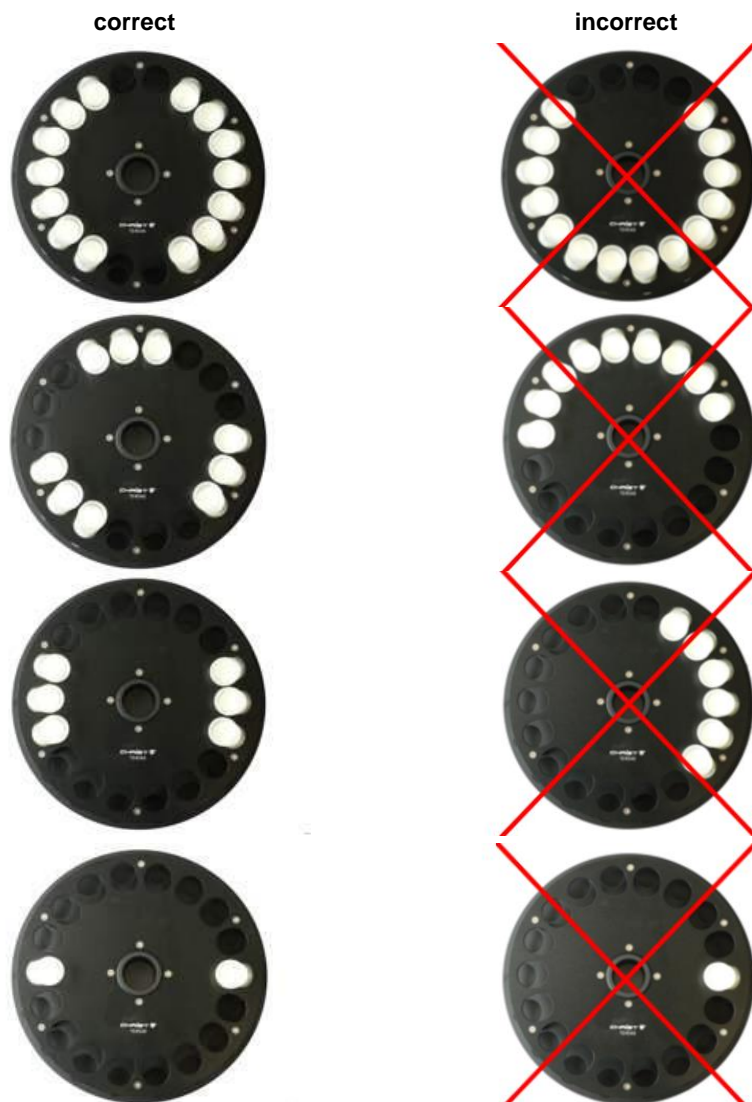

Fig. 12: Symmetrical loading of angle rotors

**6.4.2 Installation of swing-out rotors**

- Push the loaded rotor onto the rotor shaft until it reaches the stop.
- Follow the safety instructions and hazard warnings (see chapter 3 - "Safety")!

**6.4.3 Installation of accessories**

- Only use inserts that are suitable for the rotor (see chapter 11.2 - "Rotor program").
- In swing-out rotors, all places of a rotor must be loaded with buckets..
- Always load the opposite inserts of the rotors with the same accessories and fill to avoid imbalance.

**Evaporation with different tube sizes**

Working with different tube sizes is possible. In this case, however, it is very important that the inserts are installed symmetrically (see figure).

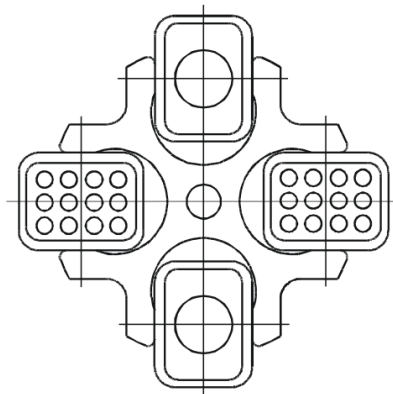

*Fig. 13: Permissible loading of the swing-out rotor with different tube sizes*

## 6 Operation

### Evaporation with low capacity

The tubes must be installed symmetrically so that the buckets and their inserts are loaded evenly to avoid imbalance.

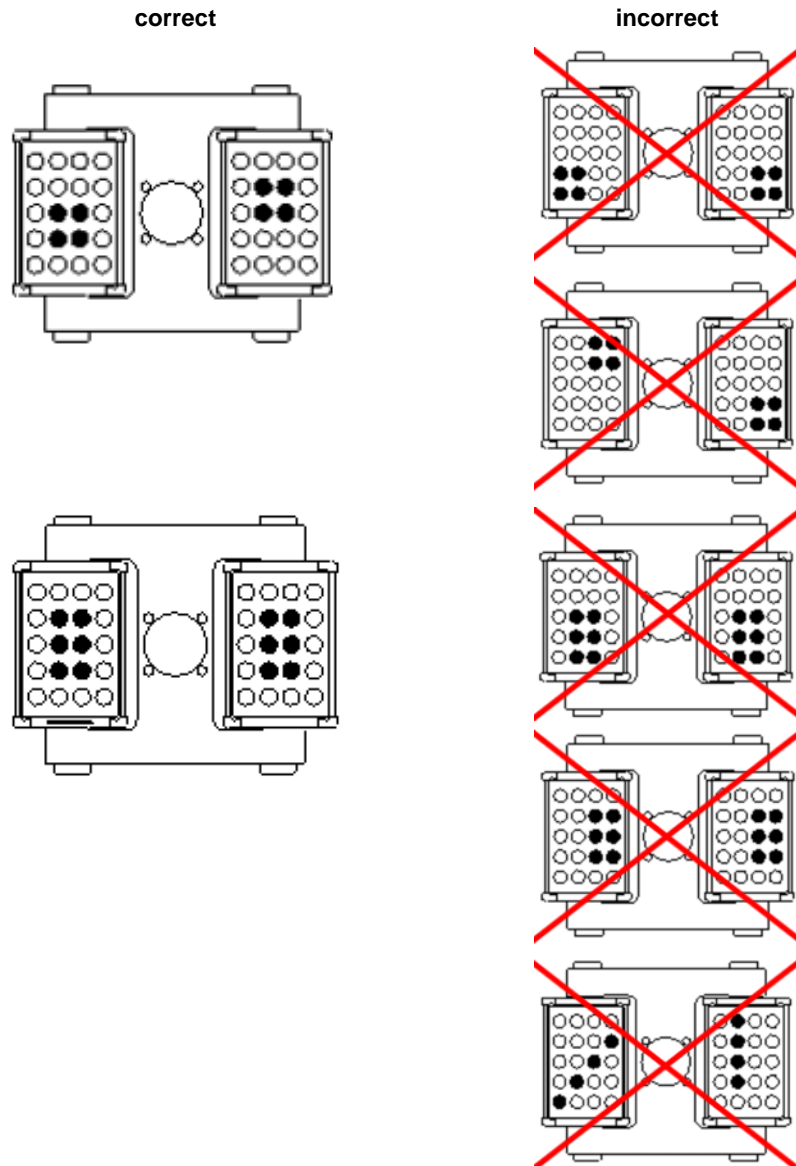

Fig. 14: Permissible loading of swing-out rotors with low capacity

#### 6.4.3.1 Tubes

- Load the tubes outside of the rotational vacuum concentrator. Solvents in the buckets or rotor blocks cause corrosion.
- Fill the tubes carefully and arrange them according to their weight.
- Follow the safety instructions and hazard warnings (see chapter 3 - "Safety")!

**6.4.3.2 Rotor blocks**

- Always load the rotor blocks symmetrically with the same accessories and fill to avoid imbalance.

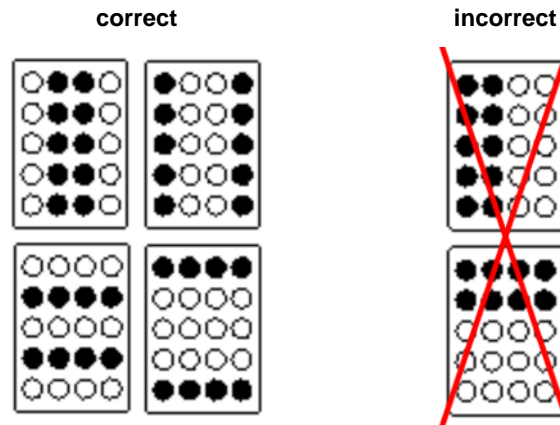

Fig. 15: Symmetrical loading of the rotor blocks

**6.4.3.3 Buckets**

- Load each bucket symmetrically to its pivotal point to ensure swinging to 90° under rotation.

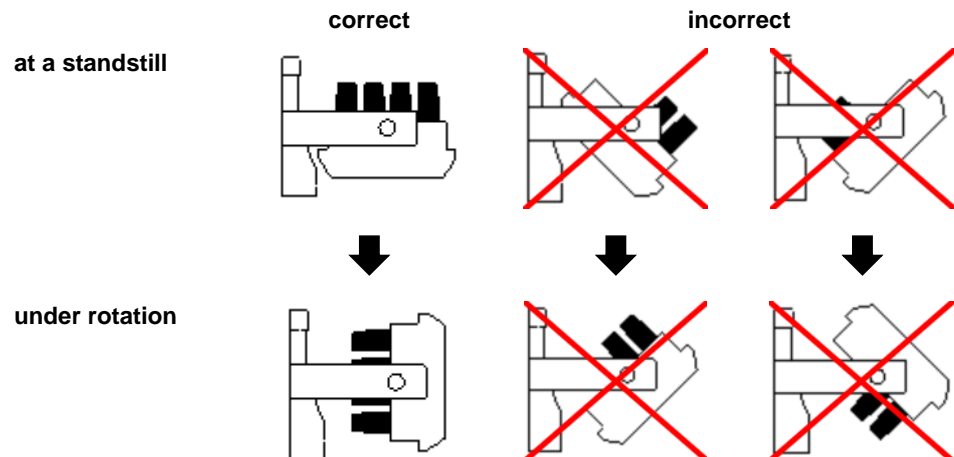

Fig. 16: Symmetrical loading of the buckets

- The balance point of the loaded bucket must be located considerably below the pivotal point. If the balance point is too near the pivotal point, the loaded bucket can be levered out of the bearings.

## 6 Operation

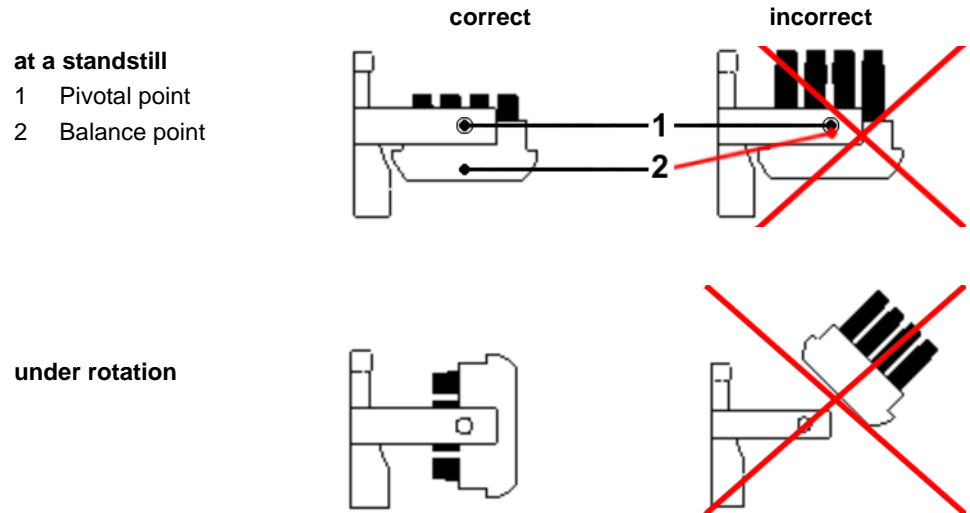

Fig. 17: Loading of buckets considering the balance point

## 6.5 CDplus control system

The control system CDplus ("Concentrator Display plus") stands for a convenient user interface for the intuitive control of evaporation processes under rotation.

### 6.5.1 User interface

- 1 Left function key
- 2 Right function key
- 3 "Up" key
- 4 "Down" key
- 5 Display

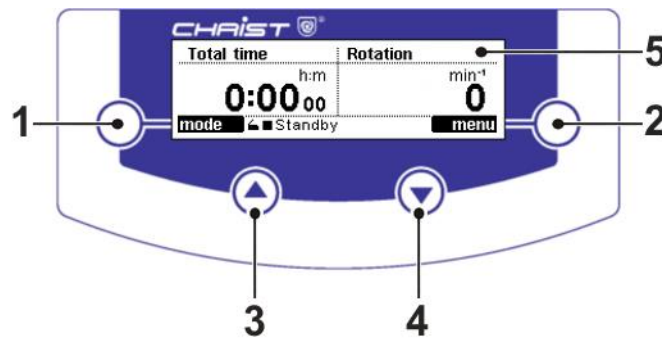

Fig. 18: User interface of the CDplus control system

#### Function keys (1+2)

The function of these keys depends on the menus and operating states of the installation. The current key function is displayed in the black field next to the key.

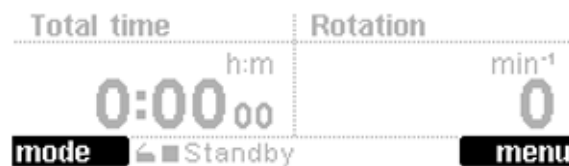

Fig. 19: Display of the assignment of the function keys; here: left key "mode", right key "menu"

#### Up and down keys (3+4)

These keys are used to select the available functions and values or to change the selected parameter values.

In addition, these keys also control the indication of the measurement value channels in the value windows. The "up" key is assigned to the left value window, whereas the "down" key controls the right value window.

- For a selection, press the "up" or "down" key repeatedly until the desired measurement value channel is indicated in the respective value window.

## 6 Operation

### Display (5)

The main window of the display is divided into three areas: the values windows, the assignment of the function keys and the status bar. The main window shows the process data, e.g. set values and actual values, menus and process-relevant information (see figure).

- 6 Values window
- 7 Assignment of the function keys
- 8 Status bar

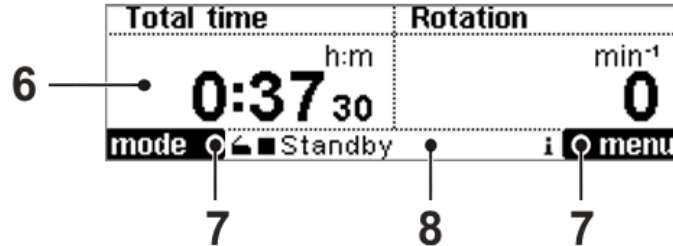

Fig. 20: Structure of the CDplus display

### Values window (6)

The value windows are displayed after the initialisation of the control system. There are two value windows with an identical layout. The indication of the measurement value channels is controlled by way of the "up" and "down" keys (see above).

- 9 Measuring channel
- 10 Set value (only shown in the run mode)
- 11 Unit of the measured value
- 12 Actual value

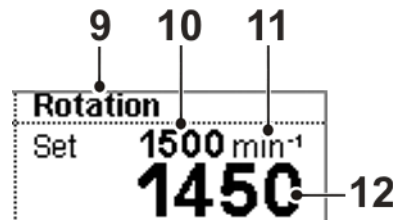

Fig. 21: Values window

The available measurement values can be displayed in the values window on the left as well as in the values window on the right so that a combination of the following values can be selected:

- Rotor speed
- Vacuum (only if a vacuum sensor is installed)
- Safety pressure (only if a vacuum sensor is installed)
- Rotor chamber temperature
- Ice condenser temperature (only if the option "Cooling trap control" is used)
- Total time (counts the time of the entire process run)
- Section time (counts the time of an individual phase, e.g. warm-up, program sections)

### Assignment of the function keys (7)

see "function keys" (1+2)



### Status bar (8)

The status bar shows information regarding the lid status, the operating mode, the active phase, and pending information. The status bar is visible at all times.

- 13 Lid status
- 14 Icon for the operating mode
- 15 Active phase
- 16 Info icon

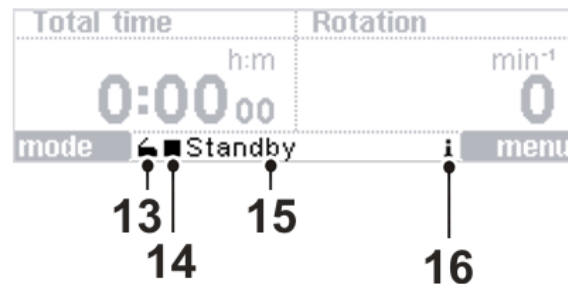

Fig. 22: Status bar

### Lid status (13)



The lid is open.

The lid is closed.

The lid is not completely closed.

- Press the right or left side of the lid down in order to close the lid completely.

### Operating mode (14)

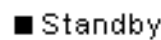

**Standby** The rotational vacuum concentrator is in the standby mode. All aggregates are switched off.



The rotational vacuum concentrator is in the run mode. The timer is deactivated.



The rotational vacuum concentrator is in the run mode. The timer is activated.

### Active phases (15)

**Open lid** The rotor is at a standstill, the lid can be opened.

**Warm-up** The vacuum pump and/or the cooling trap are within the warm-up phase.

**Evaporation manual** The RVC is within a manual-controlled evaporation run.

**Evaporation program** The RVC is within a program-controlled evaporation run.

### Pending information (16)



If any messages are pending, the info icon flashes every second to draw the user's attention to error messages, process messages, or general information concerning the process or the unit.

The messages can be displayed in the process and equipment information window (see chapter 6.5.3.4 - "Process and equipment information")

## 6 Operation

### 6.5.2 Mode

The mode selection can be activated by pressing the left-hand function key "mode" in the active values window. The following phases are available:

- Press the left-hand function key "mode". The menu "start with phase..." appears (see figure).
- Select the desired menu item with the up and down keys.
- Press the right-hand function key "enter" to confirm.

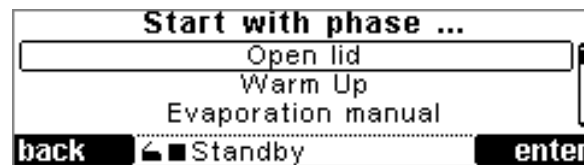

Fig. 23: Selecting the mode

#### Opening the lid

The lid can only be opened if the rotor is at a standstill. It is not possible to open the lid during an evaporation process.



During the evaporation process, the housing, the lid and the interior of the rotational vacuum concentrator can reach surface temperatures of more than +50°C.

Risk of burns!

#### Warm-up

Before starting an evaporation process, the vacuum pump and the cooling trap should warm-up until they reach their respective operating temperatures.

For this purpose, the warm-up phase can be started. The rotor can optionally be installed. The warm-up time and the set value for heating can be selected (see chapter 6.5.3.5 - "Options").

During the warm-up:

- The rotor chamber is preheated - with or without rotor - when the lid is closed.
- The vacuum pump is switched on.
- The cooling trap is switched on if it is connected via the control system with the rotational vacuum concentrator (see chapter 5.6 - "Connection of a vacuum pump and/or a cooling trap"). If there is no connection, the cooling trap must be switched on separately.

When the preset warm-up time is over, the control unit displays the following message:

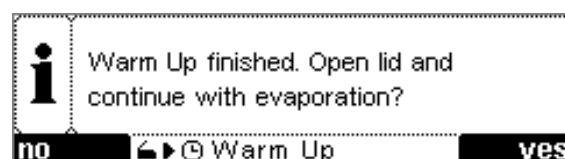

Fig. 24: Message after the warm-up

- Open the lid and remove the rotor in order to load it with the product or insert the loaded rotor.

- Close the lid. A menu appears:

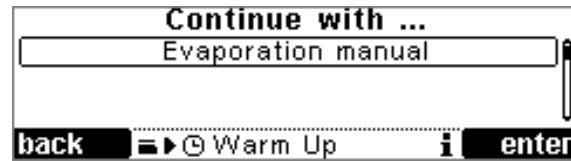

Fig. 25: Continuing the evaporation

- Continue the process by selecting "Evaporation manual" or "Evaporation program".

#### Stopping the warm-up phase prematurely

During the warm-up phase, the functions "Open lid", "Continue with phase" or "Stop warm-up" can be selected with the right-hand function key "mode".

The warm-up is stopped by selecting one of the functions.

#### **Manual or program-controlled evaporation**

If the unit is in the standby mode, the evaporation phase can be started directly. For this purpose, select from the menu "Start with phase" the item "Evaporation manual" or "Evaporation program".



The function "Evaporation program" can only be selected if a program was created before (see chapter 6.5.3.2 - "Program administration").

#### Stopping the evaporation process prematurely

If the timer is active, the evaporation process will be stopped automatically when the preset time is over. The process can also be aborted manually.

- Open the menu "Select mode" with the left-hand function key.
- Select the function "Stop evaporation".
- Press the right-hand function key to confirm.

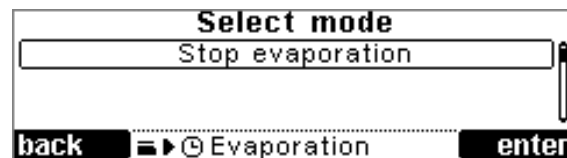

Fig. 26: Stopping an evaporation process

When the evaporation process is stopped, the chamber is completely aerated and the rotor stops. Then, the system inquires as to whether the lid should be opened.

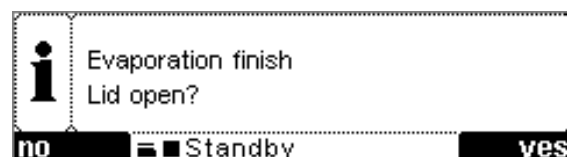

Fig. 27: Message after stopping an evaporation process

## 6 Operation

### 6.5.3 Main menu

The main menu can be activated by pressing the right-hand function key "menu" in the active values window. It contains the following items:

- Changing the set values for the manual mode (see chapter 6.5.3.1 - "Changing the set values for the manual mode ")
- Program administration (see chapter 6.5.3.2 - "Program administration")
- Special functions (see chapter 6.5.3.3 - "Special functions")
- Process- & equipment information system (see chapter 6.5.3.4 - "Process and equipment information")
- Options (see chapter 6.5.3.5 - "Options")

- 1 Menu list
- 2 Menu title
- 3 Focus
- 4 Scrollbar
- 5 Function key "Quit menu"
- 6 Function key "Open menu"

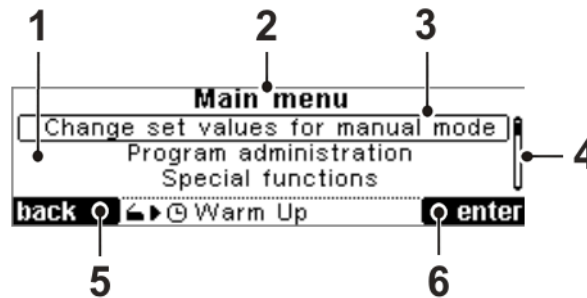

Fig. 28: Structure of the main menu

#### 6.5.3.1 Changing the set values for the manual mode

- Select the set value with the up and down keys. The selected value is displayed in a focus.



Fig. 29: Manual mode – selecting a set value

- Press the right-hand function key to start the editing mode. The focus is displayed in an inverted manner.



Fig. 30: The selected set value is displayed in an inverted manner

- Change the set value with the up/down keys.
- Press the right-hand function key "ok" to confirm.

The set value is edited. The Evaporation manual process is controlled by the following set values.

### Timer Evaporation

The time can be set between 1 minute and 200 hours. Using the down key as of the time 00:01 h:m the symbol ∞ appears. The timer is deactivated and the RVC operates continuously.

### Timer Heating

The value that is set under “Timer Evaporation” is also used for “Timer Heating”.

For some evaporation processes, however, it makes sense to reduce the heating time. In this case, the value “Timer Heating” can be changed. The value “Timer Heating” is always lower or equal to the value “Timer Evaporation”.

### Temperature

The control temperature can be set between  $-80^{\circ}\text{C}$  and  $+80^{\circ}\text{C}$ .



Because the RVC has no active cooling, it is not possible to reach temperatures below room temperature. Under certain conditions (e.g. if a frozen product is loaded) it may be reasonable to choose a temperature below room temperature.

### Vacuum (only if a vacuum sensor is installed)

This set value determines the vacuum in the rotor chamber. The value range is defined from 1,000 mbar to 0.1 mbar.

### Safety pressure (only if a vacuum sensor is installed)

When reaching the value of the → *safety pressure*, the heater for controlling the temperature of the bucket is started. The heat is supplied as long as the set value of the safety pressure is not exceeded. If the value of the safety pressure increases beyond the maximum limit, the heater will be switched off.

The set value of the safety pressure is defined at a value range from 1,000 mbar to 0.1 mbar.

- In the case of a set vacuum between 1 and 100 mbar, the set value of the safety pressure should be 5 mbar higher.
- In the case of a set vacuum between 100 and 1,000 mbar, the set value of the safety pressure should be 10 mbar above the set vacuum.

### Alarm temperature (only for RVC 2-33 CDplus with infrared heating)

The product temperature enables conclusions to be drawn concerning the end of the drying phase: When the medium has evaporated, the product sensor will no longer be cooled. As a result, the product temperature rises. Depending on the temperature sensitivity of the product, it may be useful to define a limit value, at which the heater will be switched off, via the alarm temperature. When selecting the limit value, it must be taken into consideration that the energy, which has already been supplied to the system (e.g. thermal energy from the rotor and rotor chamber), continues to heat the product even after the heater has been switched off.

The value range of the alarm temperature is between  $-20^{\circ}\text{C}$  and  $+60^{\circ}\text{C}$ .

## 6 Operation

### 6.5.3.2 Program administration

Contrary to a manual evaporation process, a program is used for a timer-controlled, pre-programmed process (evaporation program).

An evaporation program is divided into several sections. Every section of the program has set values for the time, temperature, vacuum, safety pressure, and speed.

You can create up to 16 individual evaporation programs. Up to 80 sections can be assigned to each of these programs. A program always consists of at least 3 sections.



The higher the speed is, the more thermal energy will be produced because of the waste heat of the drive unit and also because of the eddy current losses of the magnetic coupling. If thermosensitive products are processed, the speed can be set to a correspondingly low level in order to prevent a too high energy input and, thereby, the excessive heating of the product.



If the temperature increases too quickly during an evaporation process, the system is being supplied with too much energy. As a result, the vacuum may collapse, which in turn will interrupt the evaporation process and may destroy the product in the unit. In order to ensure a controlled process run, there is no sudden increase or decrease of the setpoint between the sections. Instead, the setpoint changes steadily. The defined section setpoint is reached at the end of the respective section.

Calculation of the gradient see chapter 11.1 - "Mathematical relations".

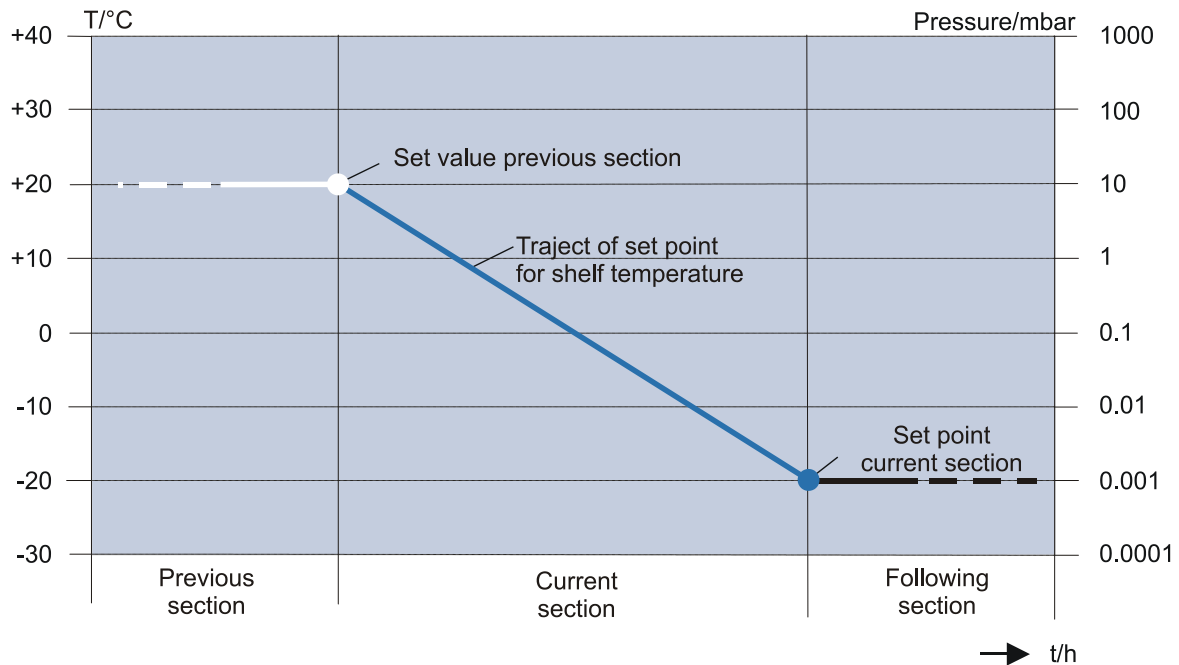

Fig. 31: Graphical representation of the course of the control setpoint

### Creating a new program

A new program can be created based on a fixed program template and adapted to specific needs by changing the set values and by adding and deleting certain sections. The control system automatically assigns a program number to every new program.

- Select "New program" from the menu "Program administration" (see figure) and confirm. The following message will appear:

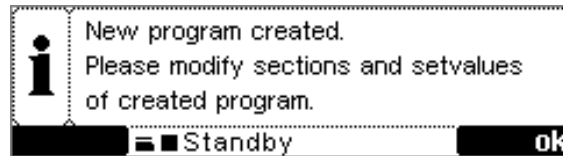

Fig. 32: Message "New program created"

- Press the right-hand function key to confirm.
- Continue as described under "Editing a program" (see below).

### Editing a program

- Select "Edit program" from the menu "Program administration" (see figure) and confirm. The program list is shown.

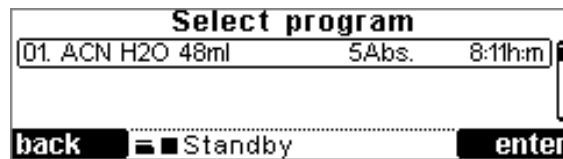

Fig. 33: Program list

- Select a program from the program list. It will be opened for editing.
- Open the menu "Program parameter" in order to change the program name. Use the function keys to position the focus in the program name. Use the up/down keys to change the character at the current focus position.
- At the last position of the program name, the right-hand key function changes to "ok" to enter the program name.

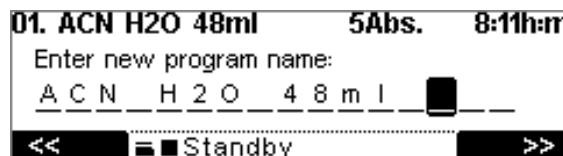

Fig. 34: Changing the program name

## 6 Operation

The sections of a program can be adapted under "Edit program sections". The set values and sections are displayed in a tabular form.

Section		Start	1	2
Zeit	h:m		0:10	1:00
Temperature	°C	30	30	60
Vacuum	mbar		24	24
<b>back</b>		Standby	<b>edit</b>	

Fig. 35: Program section table

- Use the up/down keys to scroll through the sections. The section to be edited is in the middle column of the table.
- Press the right-hand function key "edit" to confirm. The editing menu is displayed.

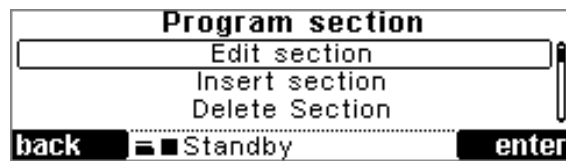

Fig. 36: Program section menu

- In this menu, the set values of the selected section can be changed, the selected section can be deleted, or a new section can be added to the selected section.
- Confirm the input and quit the menu.

### Copying a program

- Select "Copy program" from the program administration menu and confirm. The program list will be displayed.
- Select a program and confirm. A copy of the selected program will be created in a free program location.

### Deleting a program

- Select "Delete program" from the program administration menu and confirm.
- Select a program from the program list and confirm. A message will be displayed:



Abb. 37: Message for deleting a program

- Confirm the message and quit the menu.

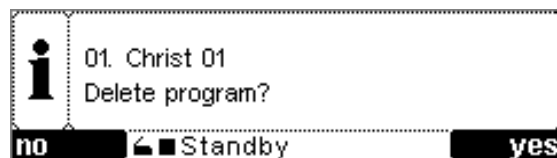

**Program memory information**

- Select "Program memory information" from the program administration menu and confirm. Information concerning free program locations and sections are displayed:

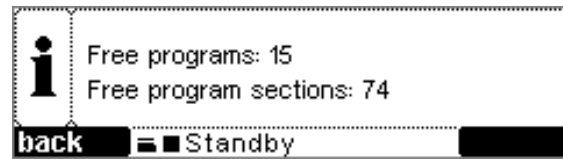

Fig. 38: Program memory information

**6.5.3.3 Special functions**
**Pressure increase test**

The → *pressure increase test* can only be performed if a vacuum sensor is installed.

Entering the set values

- Select "Special functions" from the main menu.
- Open the menu "Pressure increase test" and select "Parameter pressure increase test".
- Enter the set values, confirm and quit the menu.

Performing the pressure increase test

- Select "Special functions" from the main menu.
- Open the menu "Pressure increase test" and select "Start pressure increase test".

The pressure increase test will be performed. The test time progress and the measured pressure increase are displayed in a graphical form.

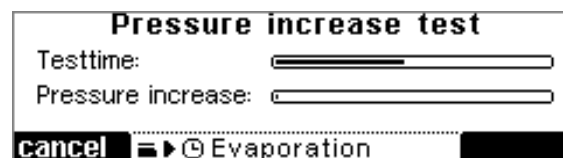

Fig. 39: Graphical presentation of the pressure increase test

When the test is finished, an information window pops up and shows the result of the pressure increase test.

## 6 Operation

### 6.5.3.4 Process and equipment information

The "Process & equipment Information " menu informs the user about any error, process, or system messages.

In the event of a message, a sound signal can be heard and the symbol " i " is displayed on the status bar. In addition, the process and equipment information is displayed. If the user is in a menu, the window will not be displayed until the user quits the main menu.

- 1 Message
- 2 Status of the Information
- 3 Number of messages pending
- 4 Function key for quitting the menu
- 5 Function key for acknowledging the message

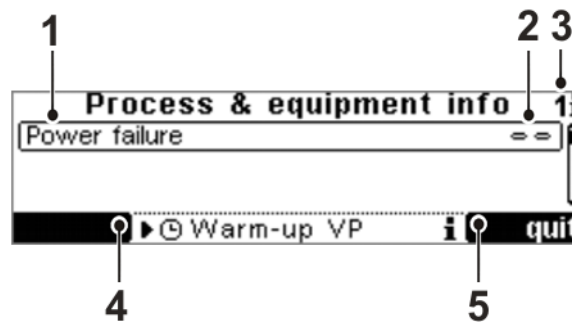

Fig. 40: Structure of the process & equipment info window

In addition, the menu can be opened at any time to check whether any messages are pending.



A detailed list of all messages can be found in chapter 7 "Malfunctions and error correction".

#### Information status

Every piece of information shown in the process & equipment information window receives a certain status:

 = Information present, not acknowledged

 ✓ Information present, acknowledged

 = Error no longer present, information not acknowledged

The sound signal continues until all the information is acknowledged.

Once some information is no longer present but has been acknowledged, the information will be removed from the process & equipment information window.

In order to quit the process & equipment information window, you have to acknowledge all of the pieces of information so that the left-hand function key "back" can be displayed.

**6.5.3.5 Options**

Fig. 41: Menu "Options"

**Change display contrast**

- Select the menu "Change display contrast".
- Change the contrast by pressing the up/down keys.
- Confirm the new setting by pressing the right-hand function key.

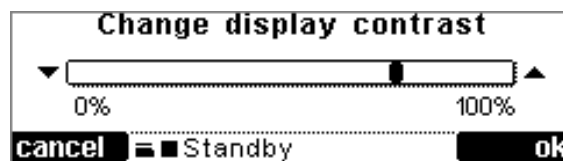

Fig. 42: Changing the contrast

**Select language**

The CDplus control system can be used in German or English.

- Select the menu "Select language".
- Select the language using the up/down keys.
- Confirm the input by pressing the right-hand function key.

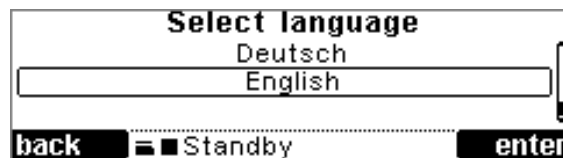

Fig. 43: Selecting a language

**Settings**

The Settings menu is used to customise the operation and process management of the control system.

- Select the value you want to set.
- Change the value using the up/down keys.
- Confirm the input by pressing the right-hand function key.

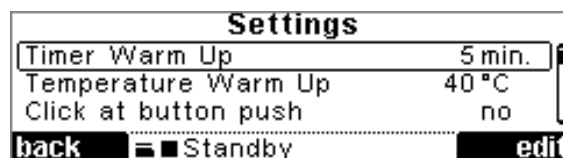

Fig. 44: Settings menu

Timer Warm-up

You can set a warm-up time between 5 and 99 minutes.

## 6 Operation

### Temperature Warm-up

During the warm-up phase, the rotor temperature is set to the set temperature.

### Click at button push

If this function is activated, a brief sound signal can be heard whenever a key is pressed.

### High temperature resolution

Temperatures are displayed in the values window with a resolution of  $\frac{1}{10}^{\circ}\text{C}$ , normally with a resolution of  $1^{\circ}\text{C}$ .

### Rotor speed

The rotor speed can be set in a range between 100 rpm and 1,750 rpm.



We guarantee that a speed of 1,350 rpm can be reached with all of the available rotors. Higher speeds are possible in individual cases.

### Continuous operation coldtrap (only if a cold trap is installed) and

### Continuous operation VP

If these options are set to "yes", the vacuum pump and the cold trap will not be switched off after the evaporation. Instead, they will remain active. This is useful if several evaporation processes are started in succession.

### Service menu

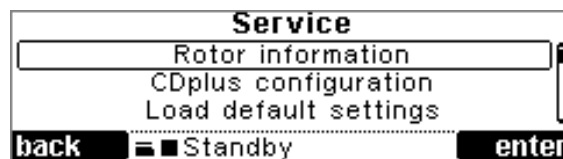

Fig. 45: Service menu

### Rotor information

This function is not supported by this type of unit.

CDplus configuration

In this menu, accessories (options) have to be configured:

- VaCuum sensor
- Remote control cold trap
- Air injection
- Triple TMM (not available for all RVC types)
- Imbalance detection (not available for all RVC types)

**NOTE**

- If an option is installed, it has to be activated with "yes".
- If the option is not installed, it has to be deactivated with "no".

Load default settings

All set values and parameters are reset to the delivery status of the RVC.  
The reset requires confirmation.

Extended service menu

The extended service menu is exclusively reserved for service engineers.  
This area is password-protected and not available to the user.

## 7 Malfunctions and error correction

# 7 Malfunctions and error correction

## 7.1 General malfunctions

Malfunctions are displayed in the menu "Process & equipment info" (see chapter 6.5.3.4 - "Process and equipment information"). A sound signal sounds when an error message is generated.

- Eliminate the source of the problem (see the following chapters).
- Acknowledge the error messages by pressing the right-hand function key.

### 7.1.1 Error messages

Error	Possible reason	Correction
<b>No vacuum sensor signal</b>	<ul style="list-style-type: none"> <li>• The control unit receives an invalid value from the vacuum sensor.</li> </ul>	<ul style="list-style-type: none"> <li>• Check the connecting cables and plug-in connections of the vacuum sensor. If necessary, replace the vacuum sensor.</li> </ul>
<b>No rotor chamber sensor signal</b>	<ul style="list-style-type: none"> <li>• The temperature sensor of the rotor chamber is disconnected or defective</li> </ul>	<ul style="list-style-type: none"> <li>• Contact the after-sales service (see chapter 7.2 - "Service contact")</li> </ul>
<b>No rotor sensor signal</b>	<ul style="list-style-type: none"> <li>• The rotor temperature sensor is disconnected or defective</li> </ul>	<ul style="list-style-type: none"> <li>• Contact the after-sales service (see chapter 7.2 - "Service contact")</li> </ul>
<b>No ice condenser sensor signal</b>	<ul style="list-style-type: none"> <li>• The data communication link to the cooling trap is interrupted, or the ice condenser temperature sensor is disconnected or defective</li> </ul>	<ul style="list-style-type: none"> <li>• Check the data link between the rotational vacuum concentrator and the cooling trap</li> </ul>
<b>Lid cannot be opened</b>	<ul style="list-style-type: none"> <li>• The rotor chamber is not aerated completely</li> </ul>	<ul style="list-style-type: none"> <li>• Aerate the rotor chamber completely</li> </ul>
<b>Lid contacts error</b>	<ul style="list-style-type: none"> <li>• The system has detected an open lid during evaporation. The rotor will be stopped immediately. The lid must be closed while the rotor is moving.</li> </ul>	<ul style="list-style-type: none"> <li>• Check the lid contacts. If necessary, contact the after-sales service (see chapter 7.2 - "Service contact")</li> </ul>
<b>Rotor overtemperature</b>	<ul style="list-style-type: none"> <li>• The maximum permissible rotor temperature of 85°C has been exceeded</li> </ul>	<ul style="list-style-type: none"> <li>• If the system does not cool down, disconnect it immediately from the power supply. Contact the after-sales service (see chapter 7.2 - "Service contact")</li> </ul>
<b>Chamber overtemperature</b>	<ul style="list-style-type: none"> <li>• The maximum permissible chamber temperature has been exceeded</li> </ul>	<ul style="list-style-type: none"> <li>• If the system does not cool down, disconnect it immediately from the power supply. Contact the after-sales service (see chapter 7.2 - "Service contact")</li> </ul>

## 7 Malfunctions and error correction

Error	Possible reason	Correction
<b>Permissible imbalance exceeded</b>	<ul style="list-style-type: none"> <li>The rotor will be stopped immediately, the process will also be stopped.               <ul style="list-style-type: none"> <li>improper loading of the rotor</li> <li>glass breakage</li> <li>uneven evaporation</li> </ul> </li> </ul>	<ul style="list-style-type: none"> <li>Balance the load and restart the rotational vacuum concentrator. If the error occurs again, contact the after-sales service (see chapter 7.2 - "Service contact")</li> </ul>
<b>VSK3000 calibration error</b>	<ul style="list-style-type: none"> <li>Incorrect calibration of the vacuum sensor VSK3000</li> </ul>	<ul style="list-style-type: none"> <li>The sensor must be recalibrated (see separate operating manual)</li> </ul>

### 7.1.2 Process messages

Error	Possible reason	Correction
<b>Mains power failure</b>	<ul style="list-style-type: none"> <li>A mains power failure will be detected if the power supply is interrupted under normal conditions (run mode).</li> </ul>	<ul style="list-style-type: none"> <li>The process will continue once the mains power is available again. The process times will be reset to zero. The set control values will be preserved.</li> </ul>
<b>Factory settings loaded</b>	<ul style="list-style-type: none"> <li>All parameters are reset to the delivery status of the system.</li> </ul>	<ul style="list-style-type: none"> <li>The factory settings will be loaded if the corresponding menu command is executed in the service menu or if an error occurred in the parameter menu.</li> </ul>
<b>No rotor detected (only Triple TMM)</b>	<ul style="list-style-type: none"> <li>Check the rotor for correct installation.</li> </ul>	<ul style="list-style-type: none"> <li>If the error occurs again, contact the after-sales service (see chapter 7.2 - "Service contact").</li> </ul>
<b>Nominal rotor speed not reached</b>	<ul style="list-style-type: none"> <li>After two minutes, the rotor has still not reached 90% of its nominal speed.               <ul style="list-style-type: none"> <li>set speed is too high</li> <li>drive moves sluggishly</li> </ul> </li> </ul>	<ul style="list-style-type: none"> <li>Check the set speed.</li> <li>When the rotor is at a standstill and the system is switched off, check whether the drive moves sluggishly, by hand. Contact the after-sales service (see chapter 7.2 - "Service contact").</li> </ul>
<b>Safety pressure not reached</b>	<ul style="list-style-type: none"> <li>The safety pressure inside the rotor chamber must be reached within 5 minutes after the start of an evaporation process.</li> </ul>	<ul style="list-style-type: none"> <li>Check whether the value that was entered for the safety pressure is not too low.</li> <li>Check the components for any possible leaks.</li> </ul>
<b>Ice condenser temperature not reached</b>	<ul style="list-style-type: none"> <li>Only if the "Cooling trap control" option is enabled: The ice condenser temperature must be <math>\leq -25^{\circ}\text{C}</math>.</li> </ul>	<ul style="list-style-type: none"> <li>If the temperature is not reached, the heater will be deactivated.</li> </ul>

## 7 Malfunctions and error correction

### 7.1.3 System messages

Error	Possible reason	Correction
Invalid system type		<ul style="list-style-type: none"> <li>Contact the after-sales service (see chapter 7.2 - "Service contact").</li> </ul>
IO communication error 0x21	<ul style="list-style-type: none"> <li>Failure of the CDplus IO module</li> </ul>	<ul style="list-style-type: none"> <li>Switch the system off and then on again. If the error occurs again, contact the after-sales service (see chapter 7.2 - "Service contact")</li> </ul>
IO communication error 0x30	<ul style="list-style-type: none"> <li>Failure of the reading unit of the electronic rotor system</li> </ul>	<ul style="list-style-type: none"> <li>Switch the system off and then on again. If the error occurs again, contact the after-sales service (see chapter 7.2 - "Service contact")</li> </ul>
IO communication error 0x40	<ul style="list-style-type: none"> <li>Failure of the motor control system</li> </ul>	<ul style="list-style-type: none"> <li>Switch the system off and then on again. If the error occurs again, contact the after-sales service (see chapter 7.2 - "Service contact")</li> </ul>
IO communication error 0x41	<ul style="list-style-type: none"> <li>Failure of the imbalance detection module</li> </ul>	<ul style="list-style-type: none"> <li>Switch the system off and then on again. If the error occurs again, contact the after-sales service (see chapter 7.2 - "Service contact")</li> </ul>

### 7.1.4 Emergency lid release

In the event of a power failure, it is possible to manually open the lid of the rotational vacuum concentrator.



**WARNING**

- Do not actuate the emergency lid release before the rotor has stopped and the pressure has been relieved.
- Do not use the emergency lid release to open the lid during normal operation. Unlocked lid locks increase the risk of accidents!

- Switch off the mains power switch and disconnect the power cord from the socket.
- Check if the rotor is at a standstill and the rotor chamber is completely aerated.
- Pull the unit a bit over the edge of the table and jack it up (see the illustration below). Ensure that the centre of gravity of the unit is still on the table. If necessary, the unit must be secured by a second person.



## 7 Malfunctions and error correction

- Unscrew the two black plastic screws (approx. 8 mm).



Fig. 46: Position of the plastic screws of the emergency lid release

- Remove the stoppers, e.g. with a screwdriver. The stoppers are connected to a mechanical release string (see the illustration below).

- 1 Release string
- 2 Stopper
- 3 Plastic screw

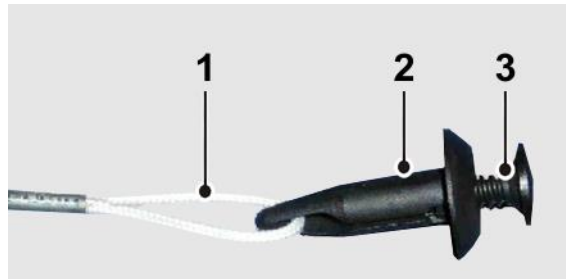

Fig. 47: Release string with stopper and screw

- Pull the stoppers with their strings vertically downwards until the lid locks unlock. Unlock the right and left lock in this way.

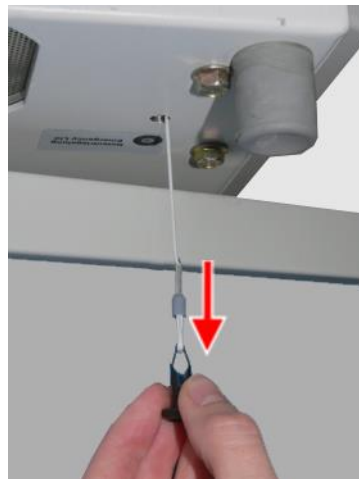

Fig. 48: Unlocking the lid locks

- Open the lid.
- After the emergency lid release has been used, reinstall both stoppers and strings in the reversed order.
- Try to locate the error source and contact the service if necessary.

## 7 Malfunctions and error correction

### 7.1.5 Small flange connections

Leakages are often due to improper small flange connections between the various components and hose connections or to leakages in the valves.

- Loosen the connection and place the centring ring (with sealing ring inside) in a centred manner between the flange connections.
- Seal the connection with the clamping ring or clamping chain by tightening the wing nut.
- Ensure that the centring ring neither slips out of place nor gets jammed.

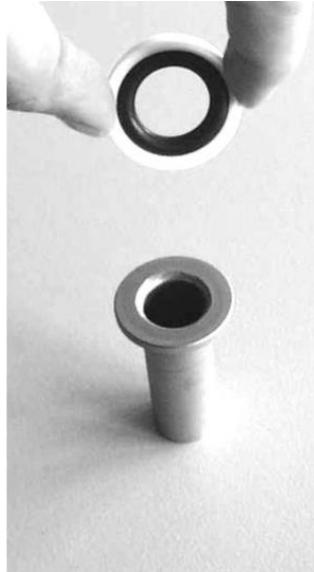

Fig. 49: Small flange and centring ring



Fig. 50: Small flange with centring ring and small flange



Fig. 51: Attaching the clamping ring

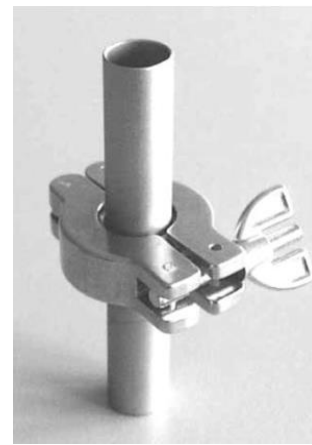

Fig. 52: Tightened clamping ring

## 7.2 Service contact

In the event of queries, malfunctions, or spare part enquiries:

### **From Germany:**

Contact

Martin Christ Gefriertrocknungsanlagen GmbH  
An der Unteren Söse 50  
37520 Osterode (Germany)  
Tel. +49 (0) 55 22 / 50 07-44 44  
E-mail: support.lab@martinchrist.de

### **Outside Germany:**

Contact our agency in your country. All agencies are listed at  
[www.martinchrist.de](http://www.martinchrist.de) → [Sales Partners]



If you would like to utilise our after-sales-service, please state the type of your RVC and its serial number.

## 8 Maintenance and service

### 8 Maintenance and service

The rotational vacuum concentrator and the accessories are subject to high mechanical stress. Thorough maintenance performed by the user extends the service life and prevents premature failure.



#### CAUTION

If corrosion or other damage occurs due to improper care, the manufacturer cannot be held liable or subject to any warranty claims.

- Use soap water or other water-soluble, mild cleaning agents for cleaning the RVC and the accessories.
- Do not use any corrosive or aggressive substances.
- Do not use solvents.
- Do not use agents with abrasive particles.
- Do not expose the RVC or its accessories to intensive UV radiation (e.g. sunlight) or thermal stress (e.g. by heat generators).

#### 8.1 Maintenance

##### 8.1.1 Rotational vacuum concentrator

- Switch off the rotational vacuum concentrator via the mains power switch and disconnect the power cord before cleaning.
- Carefully remove all product residues from the rotor chamber using a cloth.
- If the rotational vacuum concentrator has been contaminated with toxic, radioactive, or pathogenic substances, clean the rotor chamber immediately with a suitable decontamination agent (depending on the type of contamination).



#### WARNING

Take suitable precautions for your own safety if there is a risk of toxic, radioactive, or pathogenic contamination.

- Check the safety guard of the fan (at the front of the bottom side) at least once a year for dirt and clean it if necessary (e.g. with a vacuum cleaner).
- Open the rotational vacuum concentrator when it is not in use so that moisture can evaporate.

### 8.1.2 Rotor chamber

If the rotor chamber is contaminated or if glass is broken, the rotor chamber, the rotor shaft and the rotor must be cleaned immediately in order to prevent corrosion.

#### Removing the rotor shaft and the magnet coupling on rotor side

- Open the lid.
- Disconnect the power cord from the wall outlet or instrument receptacle.



**DANGER**

Hot surface!

Let the rotor chamber cool down to room temperature!

- 1 Rotor chamber
- 2 Electronic temperature measurement system of the shaft
- 3 Cap
- 4 Rotor shaft
- 5 Magnetic coupling on rotor side

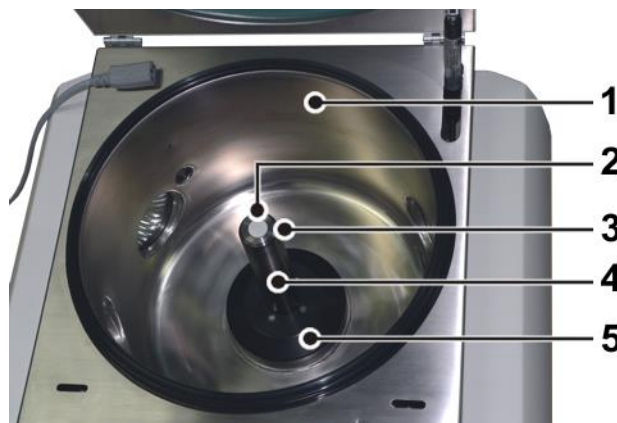

*Fig. 53: Rotor chamber with rotor shaft incl. magnet coupling*

- To get access to the bottom of the unit, turn the unit upside down or place the unit between two trestles or two tables with a sufficient number of people helping you.



**CAUTION**

The rotational vacuum concentrator weighs approx. 49 kg!

## 8 Maintenance and service

- Remove the cable cover at the bottom of the unit.

6 Cable cover

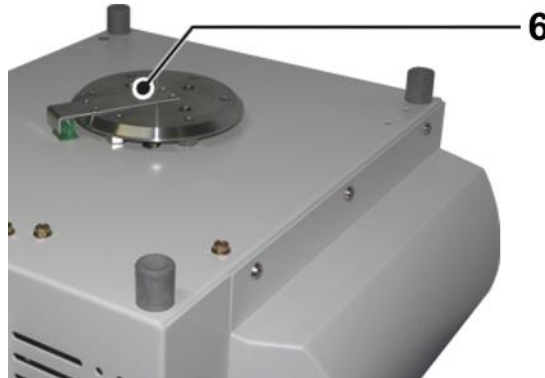

Fig. 54: Removing the cable cover at the bottom of the unit

The cables of the electronic temperature measurement system of the shaft can be seen now.

- Unscrew the two terminal screws of the electronic temperature measurement system of the shaft.

7 Terminal screws

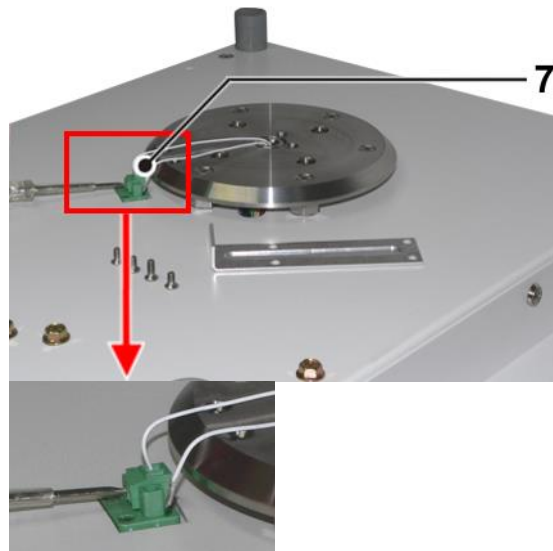

Fig. 55: Removing the terminal screws of the electronic temperature measurement system

- Turn the rotational vacuum concentrator back to its normal position (with a sufficient number of people helping you), if it was turned upside down.
- Remove the cap.



Fig. 56: Removing the cap

**8 Maintenance and service**

- Screw out the electronic temperature measurement system of the shaft. Pay attention to the corresponding cables.



*Fig. 57: Removing the electronic temperature measurement system*

- Loosen the rotor shaft incl. magnetic coupling using the hexagon socket wrench (size 5).



*Fig. 58: Loosening the rotor shaft incl. magnetic coupling*

- Remove the rotor shaft incl. magnet coupling.



*Fig. 59: Removing the rotor shaft incl. magnet coupling*

- Remove the four fastening screws on the upper side of the magnetic coupling using the L-key Torx TX15.

## 8 Maintenance and service

- Remove the magnetic coupling from the rotor shaft.



Fig. 60: Removal of the magnet coupling on rotor side

### Installation of the rotor shaft and the magnet coupling on rotor side

- Clean the rotor chamber, the rotor shaft and the magnet coupling with cleaning agent or a disinfectant.



#### CAUTION

Ensure that no cleaning agent or disinfectant gets into the opening at the bottom of the rotor chamber.  
This can lead to irreparable damage at the motor.

- Clean the cap and grease the O-ring of the cap slightly with vacuum grease.
- Install the components or assemblies in a reversed order.



#### CAUTION

When installing the rotor shaft, ensure that the O-ring used to seal the rotor chamber is fitted correctly.



**8 O-Ring of the rotor shaft**

- Grease the O-ring with vacuum grease to ensure that it does not get out of place.

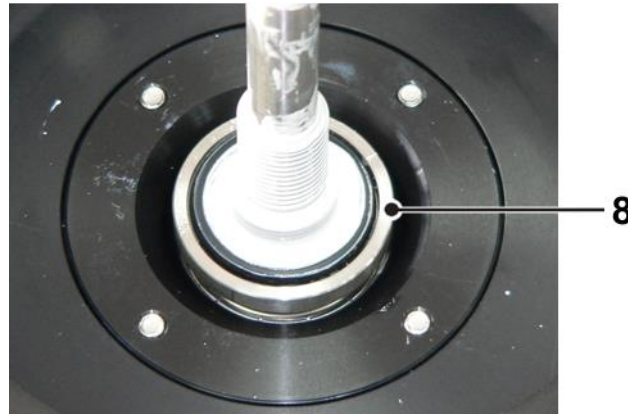

*Fig. 61: O-ring at the bottom of the rotor shaft*

- Plug in the mains plug and switch the rotational vacuum concentrator on.
- Perform a test run.

**8.1.3 Accessories**

**CAUTION**

For the care of the accessories, special safety measures must be considered as these are measures that will ensure operational safety at the same time.

Chemical reactions as well as stress-corrosion (combination of oscillating pressure and chemical reaction) can affect or destroy the metals. Barely detectable cracks on the surface can expand and weaken the material without any visible signs.

- Check the material regularly (at least once a month) for
  - cracks
  - visible damage of the surface
  - pressure marks
  - signs of corrosion
  - other changes.
- Replace any damaged components immediately for your own safety.
- Immediately rinse off the rotors or accessories if any liquids that may cause corrosion come into contact with them.
- Clean the accessories outside the rotational vacuum concentrator once a week or preferably after each use.
- If the rotors or accessories have been contaminated with toxic, radioactive, or pathogenic substances, clean them immediately with a suitable decontamination agent (depending on the type of contamination). Take suitable precautions for your own safety if there is a risk of toxic, radioactive, or pathogenic contamination.

## 8 Maintenance and service

---

### 8.1.3.1 Aluminium accessories

Especially aluminium parts are susceptible to corrosion.

- Acid-containing cleaning agents and alkaline cleaning agents must be avoided.
- Grease aluminium parts at least once a week with slushing oil for the protection against corrosion.

This essentially increases their service life and reduces susceptibility to corrosion.

### 8.1.4 Glass breakage



#### CAUTION

In the case of glass breakage, immediately remove all glass particles (e.g. with a vacuum cleaner). Replace the rubber cushions since even thorough cleaning will not remove all glass particles.

Glass particles will damage the surface coating (e.g. anodising) of the buckets, which will then lead to corrosion.

Glass particles in the rubber cushions of the buckets will cause glass breakage again.

Glass particles on the pivot bearing of the load-bearing bolts prevent the buckets and rotor blocks from swinging evenly, which will cause an imbalance.

Glass particles in the rotor chamber will cause metal abrasion due to the circulation. This metal dust will not only pollute the rotor chamber, rotor, and materials to be evaporated but also damage the surfaces of the accessories, rotors, and rotor chamber.

#### **In order to completely remove the glass particles and metal dust from the rotor chamber**

- Grease the upper third of the rotor chamber with e.g. Vaseline.
- Then, let the rotor rotate for a few minutes at maximum speed and atmospheric pressure. The glass and metal particles will now collect at the greased part.
- Remove the grease with the glass and metal particles with a cloth.
- If necessary, repeat this procedure.
- Clean the rotor shaft.

## 8.2 Disinfection of the rotor chamber and accessories

- Use commercially-available disinfectants such as, for example, Incidur<sup>®</sup>, Meliseptol<sup>®</sup>, Sagrotan<sup>®</sup>, Buraton<sup>®</sup> or Terralin<sup>®</sup> (available at chemist's shops or drugstores).
- The rotational vacuum concentrator and the accessories consist of various materials. A possible incompatibility must be considered.
- Before using cleaning or decontamination agents that were not recommended by us, contact the manufacturer to ensure that such a procedure will not damage the rotational vacuum concentrator.
- For autoclaving, consider the continuous heat resistance of the individual materials.
- Please contact us if you have any queries (see chapter 8.4 - "Service").



**DANGER**

If dangerous materials (e.g. infectious and pathogenic substances) are used, the RVC and the accessories must be disinfected.

## 8.3 Autoclaving

The service life of the accessories essentially depends on the frequency of autoclaving and use.

- Remove the existing O-rings so that the trapezoid notch can be reached by the hot steam. This prevents the formation of humidity in the notch..
- Replace the accessories immediately when the parts show changes in colour or structure or in the occurrence of leaks etc.

Accessories	Max. temp [°C]	Min. time [min]	Max. time [min]	Max. cycles
Glass tubes	134-138	3	40	-
Polycarbonate tubes	115-118	30	40	20
Polypropylene tubes	115-118	30	40	30
Teflon tubes	134-138	3	5	100
Aluminium rotors	134-138	3	20	-
Aluminium accessories	134-138	3	20	-

## 8 Maintenance and service

### 8.4 Service



**DANGER**

In the event of service work that requires the removal of the panels, there is a risk of electric shock or mechanical injury. Only qualified specialist personnel is authorised to perform this service work.

The rotational vacuum concentrator is subject to high mechanical stress. In order to be able to withstand this high level of stress, high-quality components were used during the production of the rotational vacuum concentrators. Nevertheless, wear cannot be excluded and it may not be visible from the outside.

This is why we recommend having the rotational vacuum concentrator checked by the manufacturer during an inspection once per year in the operating state and once every three years in the dismantled state.

Information and appointments:

#### **In Germany:**

Contact

Martin Christ Gefriertrocknungsanlagen GmbH

An der Unteren Söse 50

37520 Osterode

Tel. +49 (0) 55 22 / 50 07-44 44

E-mail: support.lab@martinchrist.de

#### **Outside Germany:**

- Contact our agency in your country. All agencies are listed at [www.martinchrist.de](http://www.martinchrist.de) → [Sales Partners]



**NOTE**

If you would like to utilise our service, please state the type of your RVC and its serial number.

### 8.5 Return of defective parts

Although we exercise great care during the production of our products, it may be necessary to return a unit or accessory to the manufacturer.

In order to ensure the quick and economical processing of returns of freeze-dryers, rotational vacuum concentrators, spare parts, or accessories, we require complete and extensive information concerning the process. Please fill in the following forms completely, sign them, enclose them with the return package, and send them together with the product to:

Martin Christ Gefriertrocknungsanlagen GmbH

An der Unteren Söse 50

37520 Osterode (Germany)

**1. Declaration of decontamination**

As a certified company and due to the legal regulations for the protection of our employees and of the environment, we are obliged to certify the harmlessness of all incoming goods. For this purpose, we require a declaration of decontamination.

- The form must be filled in completely and signed by authorised and specialised personnel only.
- Affix the original form in a clearly visible manner to the outside of the packaging.



We will return the unit if no declaration of decontamination is provided!

**2. Form for the return of defective parts**

This form is for the product-related data. They facilitate the assignment, and they enable the quick processing of the return. If several parts are returned together in one packaging, please enclose a separate problem description for every defective part.

- A detailed problem description is necessary in order to perform the repair quickly and economically.
- Upon request, we will prepare and submit to you a cost estimate prior to performing the repair. Please confirm such cost estimate within 14 days. If the cost estimate has still not been confirmed after 4 weeks, we will return the unit. Please note that you must bear the incurred costs.



The unit must be packaged in a transport-safe manner. Please use the original packaging, if at all possible.

If the product is dispatched to us in unsuitable packaging, you will be charged the cost for returning it to you in new packaging.

The forms can be downloaded online from  
[www.martinchrist.de](http://www.martinchrist.de) → [Service] → [Overhaul, repair and leak testing].

## **9 Disposal**

---

### **9 Disposal**

#### **9.1 Disposal of the RVC**

Martin Christ Gefriertrocknungsanlagen GmbH is a registered manufacturer of electric and electronic devices that are solely intended for commercial use.

- Comply with all local rules and regulations.

#### **9.2 Disposal of the packaging**

- Dispose of the packaging, after having separated the individual materials.
- Comply with all local rules and regulations.

## 10 Technical data

Manufacturer:	Martin Christ Gefriertrocknungsanlagen GmbH
Type:	<b>RVC 2-33 IR</b>
Order number:	101244

Performance data	
Temperature:	+30 °C to +80 °C
Speed:	1,750 rpm
Relative centrifugal force:	530 x g
Max. permissible imbalance:	50 g
Max. density of material at process start:	2 kg / dm <sup>3</sup>

Connection requirements	
Electrical connection:	1 x 230 V / 50/60 Hz
Protection class:	I
IP code:	11
Apparent power:	1.5 kVA
Nominal current:	2.5 A
Mains fuse:	6.3 A F
Stop valve connection:	230 V, 50 Hz, 20 W max.
Pressure control valve connection:	230 V, 50 Hz, 20 W max.
Vacuum pump connection:	230 V, 50 Hz, 3,5 A max.

Physical data	
Dimension of the unit	
Height:	315 mm
Height with open lid:	715 mm
Width:	550 mm
Depth:	520 mm + 20 mm vacuum connection
Dimensions of the rotor chamber	
Inside diameter:	330 mm
Height, inside:	222 mm
Max. lid opening angle:	approx. 80°
Weight:	approx. 49 kg
Noise level according to DIN 45635:	49 dB (A)
EMC according to EN 55011:	Class B

## 10 Technical data

Equipment connections	
Vacuum connection:	Small flange connection DN25KF (ISO 28403, DIN 2861)
Aeration valve:	Hose nozzle, outside diameter 4.5mm max. (DN2.5) or with air filter
Micro injection valve:	Hose nozzle, outside diameter 4.5mm max. (DN2.5) or with air filter
Mains input:	IEC C13 connector
Stop valve:	IEC C14 connector
Pressure control valve:	IEC C14 connector
Vacuum pump:	IEC C14 connector
Vacuum sensor:	M8 plug-and-socket connector
Serial interface:	SUB D-9 RS232 / Remote

### 10.1 Ambient conditions

- Use in closed spaces
- Altitudes up to 2,000 m
- Ambient temperature between +5°C and +25°C
- Maximum relative humidity of 80%
- Mains voltage fluctuations of up to  $\pm 10\%$  of the rated voltage

### 10.2 Technical documentation

The technical documentation of this rotational vacuum concentrator (e.g. circuit diagrams and the safety data sheets of the manufacturers are not attached to this operating manual.

You can order these documents from our service department (see chapter 7.2 - "Service contact").



## 11 Appendix

### 11.1 Mathematical relations

The automatic processes in the "Programmer module" menu (see chapter 6.5.3.2 - "Program administration") are based on the following considerations:

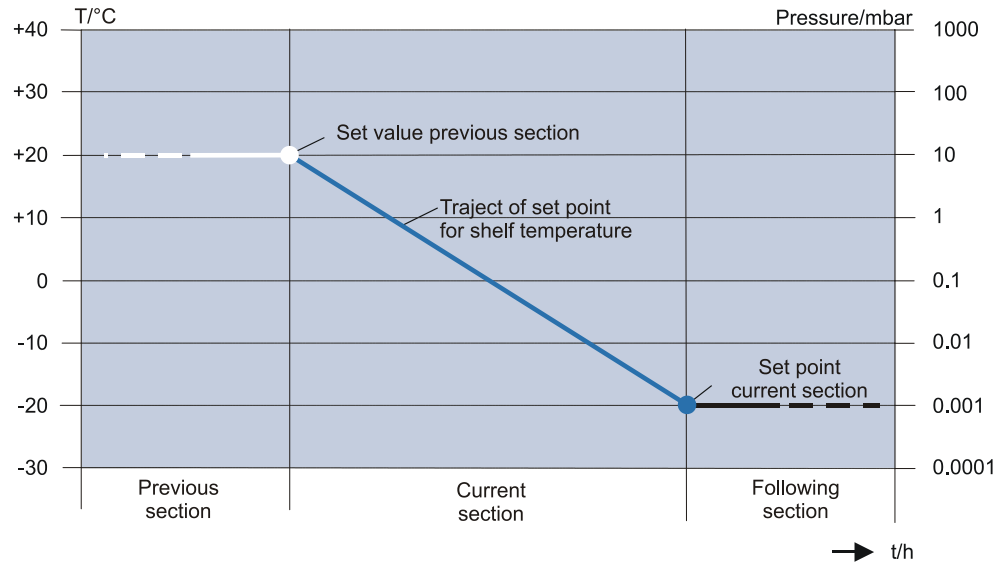

Fig. 62: Graphical representation of the course of the control setpoint

#### Calculation of the control set value and of the gradient for the temperature:

$$\text{gradient} = \frac{\text{set value of current section} - \text{set value of previous section}}{\text{section time of current section}} \quad [^{\circ}\text{C}/\text{min}]$$

$$\text{control set value} = \text{set value of previous section} + \text{elapsed section time} \cdot \text{gradient} \quad [^{\circ}\text{C}]$$

Example:

Section	Set values	
	Section time [h:min]	Temperature [°C]
Preceding	...	30
Current	1:00	60

$$\text{gradient} = \frac{60^{\circ}\text{C} - 30^{\circ}\text{C}}{60 \text{ min}} = \frac{30^{\circ}\text{C}}{60 \text{ min}} = 0.5^{\circ}\text{C}/\text{min}$$

After an elapsed section time of 30 minutes, for example, the control set value for the temperature is:

$$\text{Control set value}_{(t=30\text{min})} = 30^{\circ}\text{C} + 30 \text{ min} \cdot 0.5^{\circ}\text{C}/\text{min} = 45^{\circ}\text{C}$$

#### Calculation of the control set value for the vacuum:

$$\text{control set value} = 10^{\text{LOG10}(\text{set value prev. sect.}) + \left( \frac{\text{LOG10}(\text{set value current sect.}) - \text{LOG10}(\text{set value prev. sect.})}{\text{section time of current section}} \right) \cdot \text{elapsed section time}} \quad [\text{mbar}]$$

## 11 Appendix

---

### 11.2 Rotor program

The actual rotor program can be downloaded from  
[www.martinchrist.de/Products/RVC](http://www.martinchrist.de/Products/RVC) → [unit type].

### 11.3 Overview of evaporation times (RVC 2-33 CDplus with infrared heating)

	Vessel	Number of samples	Sample volume (ml)	Temperature (°C)	Pump	Cooling trap	Total time (min)
<b>Water</b>	100 ml test tube	12	50	30	RC 6	yes	625
	100 ml test tube	12	50	45	RC 6	yes	370
	100 ml test tube	12	50	60	RC 6	yes	285
	100 ml test tube	12	50	80	RC 6	yes	240
<b>Acetonitrile</b> C <sub>2</sub> H <sub>3</sub> N	100 ml test tube	12	50	30	RC 6	yes	112
	100 ml test tube	12	50	45	RC 6	yes	90
	100 ml test tube	12	50	60	RC 6	yes	75
	100 ml test tube	12	50	80	RC 6	yes	75
<b>1,4 Dioxane</b> C <sub>4</sub> H <sub>8</sub> O <sub>2</sub>	100 ml test tube	12	50	30	RC 6	yes	150
	100 ml test tube	12	50	45	RC 6	yes	85
	100 ml test tube	12	50	60	RC 6	yes	80
	100 ml test tube	12	50	80	RC 6	yes	60
<b>DMSO</b> C <sub>2</sub> H <sub>6</sub> OS	100 ml test tube	12	50	45	RC 6	yes	320
<b>Toluol</b> C <sub>6</sub> H <sub>5</sub> CH <sub>3</sub>	100 ml test tube	12	50	30	RC 6	yes	105
	100 ml test tube	12	50	45	RC 6	yes	70
	100 ml test tube	12	50	60	RC 6	yes	65
	100 ml test tube	12	50	80	RC 6	yes	50
<b>Ethanol</b> C <sub>2</sub> H <sub>6</sub> O	100 ml test tube	12	50	30	RC 6	yes	130
	100 ml test tube	12	50	45	RC 6	yes	95
	100 ml test tube	12	50	60	RC 6	yes	85
	100 ml test tube	12	50	80	RC 6	yes	85

## 11 Appendix

	Vessel	Number of samples	Sample volume (ml)	Temperature (°C)	Pump	Cooling trap	Total time (min)
<b>Methanol</b>	100 ml test tube	12	50	30	RC 6	yes	130
CH <sub>3</sub> OH	100 ml test tube	12	50	45	RC 6	yes	105
	100 ml test tube	12	50	60	RC 6	yes	90
	100 ml test tube	12	50	80	RC 6	yes	75
<b>n-Hexan</b>	100 ml test tube	12	50	30	RC 6	yes	30
C <sub>6</sub> H <sub>14</sub>	100 ml test tube	12	50	45	RC 6	yes	28
	100 ml test tube	12	50	60	RC 6	yes	25

## 11.4 Brief operating instructions

1. Switch on the system at the mains power switch down on the right side of the unit.
2. Switch on the cooling trap and/or the vacuum pump.
3. Close the lid.
4. Starting the warm-up phase:
  - Enter the set values for the warm-up phase into "menu" – "options" – "Timer warm-up" und "Temperature warm-up", confirm your entries and quit the menu.
  - Press the left-hand function key "mode".
  - Select the "Warm-up" menu and confirm.
  - Open the lid when the warm up phase has ended.
  - Install the rotors and close the lid.
5. Changing the set values for time, temperature, vacuum and safety pressure:
  - Select "menu" with the right-hand function key.
  - Select "Change set values for manual mode" from the main menu.
  - Select the set value by using the up/down keys and confirm with the right-hand function key "edit".
  - Change the set value by using the up/down keys and confirm with the right-hand function key "ok".
  - Quit the menu with the left-hand function key.
6. Starting the process "Evaporation manual" or "Evaporation program":
  - Open the menu "Start with phase..." by pressing the left-hand function key "mode".
  - Select "Evaporation manual" or "Evaporation program" using the up/down keys.
  - Start the evaporation process by pressing the right-hand function key.
  - The function "Evaporation program" can only be selected if a program has been created before.
  - The start of the evaporation process starts the following automatic process run:
    - The rotor speed increases (rotating direction left),
    - At 70% of the selected maximum speed: the aeration valve closes automatically (to avoid delays in boiling),
    - At 80% of the selected maximum speed: the stop valve opens the connection to the vacuum pump,
    - Further speed increase until the preselected maximum rotor speed is reached.
7. Interrupting an evaporation process:
  - Press the left-hand function key "mode".
  - Select "Stop evaporation" and confirm.

Without an interruption, the evaporation process ends after the preselected time. The following process runs automatically:

  - At maximum speed: the stop valve closes the connection to the vacuum pump, the aeration valve opens; the rotor speed is maintained for 30 sec (aeration phase, to avoid delays in boiling).
  - Rotor decelerates until it is at a standstill. After the standstill of the rotor the lid can be opened in order to remove the rotors.

## 11 Appendix

### Function and control elements:

- 1 Lid
- 2 Rotor chamber
- 3 Control panel
- 4 Lid lock device
- 5 Rotor shaft
- 6 Mains power switch
- 7 Electrical vacuum measuring sensor connection
- 8 Option: serial interface RS 232
- 9 Option: serial interface Remote
- 10 Name plate
- 11 Power supply connection of the vacuum pump
- 12 Power supply connection of the pressure control valve
- 13 Valve block
- 14 Vacuum connection
- 15 Equipotential bonding screw
- 16 Mains connection and mains fuse protection
- 17 Power supply connection of the stop valve

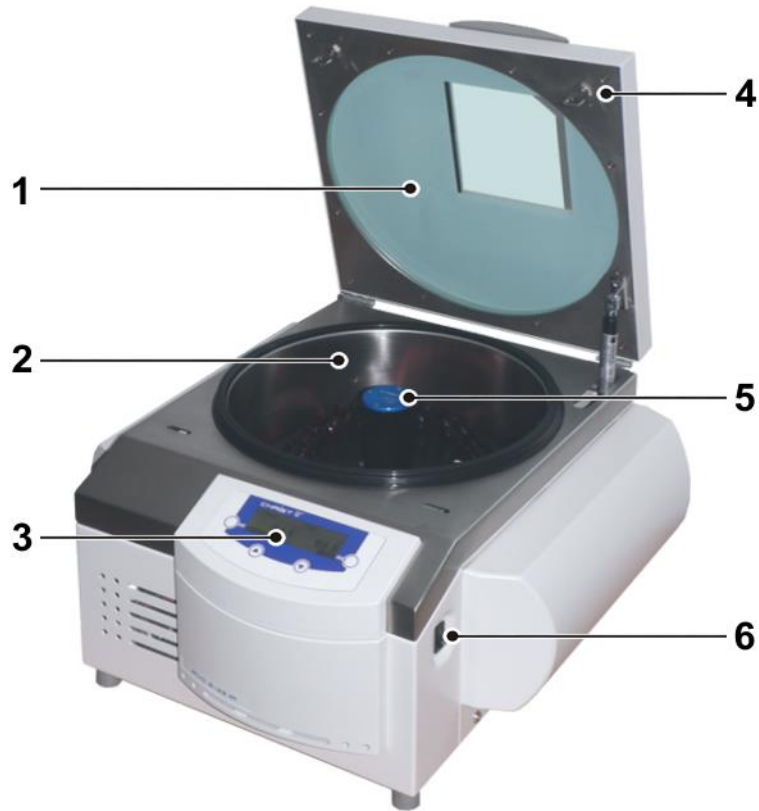

Fig. 63: Total view of the RVC



Fig. 64: Rear view of the RVC

## 11.5 EC declaration of conformity



### **EC – DECLARATION OF CONFORMITY**

**in accordance with the EC Machinery Directive 2006/42/EC, annex II, part 1, section A**

The product named hereinafter was developed, designed, and manufactured in compliance with the relevant, fundamental safety and health requirements of the listed EC directives.

In the event of modifications that were not authorised by us or if the product is used in a manner that is not in line with the intended purpose, this declaration will be rendered void.

<i>Product name:</i>	Rotational Vacuum Concentrator
<i>Product type:</i>	RVC 2-33 CDplus with infrared heating
<i>Order number:</i>	101244
<i>Directives:</i>	2006/42/EG Machinery Directive 2014/35/EU Low Voltage Directive 2014/30/EU EMC Directive

**Martin Christ Gefriertrocknungsanlagen GmbH**

An der Unteren Söse 50  
 37520 Osterode  
 Germany

Authorised representative  
 for CE matters:  
 S. Krippendorff

Osterode, 18/02/2016



M. Christ, Management

CE\_MaschRL\_RVC2-33\_CDplus\_IR\_2015-12-14\_en.docx

## 11 Appendix

---



## 11.6 Declaration of conformity – China RoHS 2



### DECLARATION OF CONFORMITY

#### China RoHS 2 (Administrative Measures for the Restriction of the Use of Hazardous Substances in Electrical and Electronic Products)

Freeze-dryer models: Alpha 1-2 LDplus, Alpha 1-4 LDplus, Alpha 2-4 LDplus, Alpha 1-4 LSCbasic, Alpha 2-4 LSCbasic, Alpha 1-4 LSCplus, Alpha 2-4 LSCplus, Beta 1-8 LDplus, Beta 2-8 LDplus, Beta 1-8 LSCbasic, Beta 2-8 LSCbasic, Beta 1-8 LSCplus, Beta 2-8 LSCplus, Gamma 1-16 LSCplus, Gamma 2-16LSCplus, Delta 1-24 LSCplus, Delta 2-24 LSCplus

Rotational Vacuum Concentrator models: RVC 2-18 CDplus, RVC 2-18 CDplus HCl-resistant, RVC 2-25 CDplus, RVC 2-33 CDplus, RVC 2-33 CDplus with infrared heating

Christ Gefriertrocknungsanlagen GmbH has made reasonable effort to avoid the use of hazardous substances in the products (freeze-dryers and RVC).

A Product Conformity Assessment (PCA) was performed in order to determine whether the concentration of harmful substances in all homogeneous materials of the component parts is above or below the MCV limit (Maximum Concentration Value limit) as defined in GB/T 26572:

Mercury and its compounds: 0.1 %      Cadmium (Cd) and its compounds: 0.01 %  
 Lead (Pb) and its compounds: 0.1 %      Hexavalent chromium (Cr (VI)) and its compounds: 0.1 %  
 Polybrominated biphenyls (PBB): 0.1 %      Polybrominated diphenyl ethers (PBDE): 0.1 %

表1 产品中有害物质的名称及含量  
 Table 1: Name and content of hazardous substances in the product

部件名称 Component part (PCA)	有害物质 Hazardous substance					
	铅 Lead (Pb)	汞 Mercury (Hg)	镉 Cadmium (Cd)	六价铬 Hexavalent Chromium (Cr (VI))	多溴联苯 Poly-brominated biphenyls (PBB)	多溴二苯醚 Polybrominated diphenyl ethers (PBDE)
Electronic PCB, cables	X <sup>1)</sup>	○	○	○	○	○
Display	○	○	○	○	○	○
Housing	X <sup>2)</sup>	○	○	○	○	○
Base, metal, accessories	X <sup>2)</sup>	○	○	○	○	○

本表格依据SJ/T 11364的规定编制。  
 This table is made according to SJ/T 11364.

## 11 Appendix



O: 表示该有害物质在该部件所有均质材料中的含量均在GB/T 26572规定的限量要求以下。  
Indicates that the content of the harmful substance in all homogeneous materials of the component part is below the limit as defined in GB/T 26572.)

X: 表示该有害物质至少在该部件的某一均质材料中的含量超出GB/T 26572规定的限量要求。(企业可在此处, 根据实际情况对上表打“X”的技术原因进行进一步说明。)  
Indicates that the content of the harmful substance in at least one homogeneous material of the component part exceeds the limit as defined in GB/T 26572. (Contact the manufacturer for further technical information according to the actual situation.)

1) Contains parts in compliance with exemptions 6c, 7c.I, 7c.II and 37 of 2011/65/EU RoHS.

2) Contains parts in compliance with exemptions 6a, 6b and 6c of 2011/65/EU RoHS.

Apart from the exemptions given in this table, none of the substances listed above have been intentionally added to the product or metallic coatings.

### **Martin Christ Gefriertrocknungsanlagen GmbH**

An der Unteren Söse 50  
37520 Osterode  
Germany

Osterode, 16/03/2018



General Manager

## 12 Glossary

### **Boiling retardation**

The temperature of a liquid can rise above the boiling point without the liquid actually starting to boil. Vibrations or shocks quickly lead to the formation of a large gas bubble that escapes explosively from the vessel. This phenomenon is known as boiling retardation. It occurs when neither the liquid nor the wall of the vessel include any condensation nuclei at which vapour bubbles might form.

### **Pressure increase test**

The pressure increase test is used to determine whether the evaporation in the rotor chamber is complete. During the pressure increase test, the rotor chamber is separated from the cooling trap or vacuum pump by way of the stop valve. The system evaluates the pressure increase that is caused by any additionally released steam.

In order to perform the pressure increase test, limits for the pressure increase as well as the test duration must be defined beforehand.

### **Relative centrifugal force**

The relative centrifugal force is the acceleration that the samples are subjected to during the rotation. The acceleration is stated as a multiple of the mean gravitational acceleration  $g$ . It can be increased by increasing the radius inside the rotor chamber and by increasing the speed. These three parameters are interdependent and linked with each other via the following formula:

$$\text{Relative centrifugal force } RCF = 11.18 \times 10^{-6} \times r \times n^2$$

*r = radius in cm*

*n = speed in rpm*

*RCF without any dimension*

## 12 Glossary

### Safety pressure

Since the vacuum has a dominating influence on the product temperature, Martin Christ Gefriertrocknungsanlagen GmbH has integrated a so-called safety pressure function into their units in order to protect the products. If the pressure inside the rotor chamber rises too quickly – above the safety limit – the energy supply of the unit will be interrupted so that the evaporation process slows down.

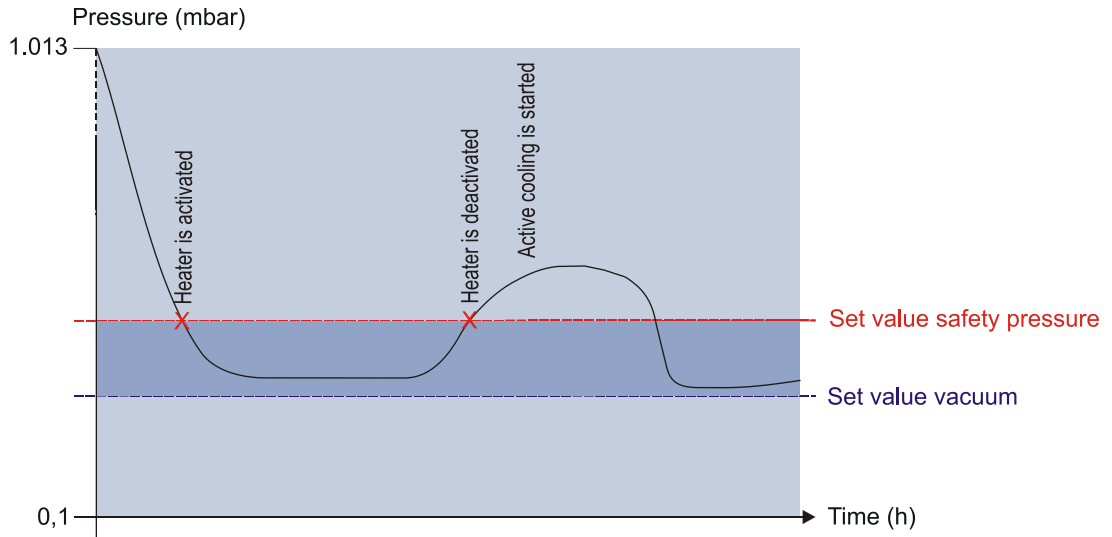

Fig. 65: Diagram describing the safety pressure function

## 13 Index

### A

Accessories .....	9, 18
Accessories, cleaning and care.....	70
Accident prevention .....	17
Active phases .....	43
Advantages of the rotational vacuum concentration.....	13
Aeration and micro injection valve (Valve block) .....	27
Aeration valve .....	77
Aluminium accessories .....	72
Aluminium accessories, cleaning and care.	71
Aluminium rotor.....	72
Ambient conditions.....	77
Ambient temperature .....	77
Apparent power .....	11, 76
Assignment of the function keys.....	42
Autoclaving .....	72

### B

Boiling retardation.....	88
Brief operating instructions.....	82
Bucket.....	39

### C

Calculation of the control set value and of the gradient for the temperature .....	78
Calculation of the control set value for the vacuum .....	78
Care of the accessories .....	70
CDplus configuration.....	56
CDplus control system .....	41
CE-Zeichen gemäß Richtlinie 2006/42/EG.	15
Chamber overtemperature .....	58
Change display contrast.....	55
Changing the set values for the manual mode .....	47
Chemical and biological safety.....	19
China RoHS 2 – Declaration of conformity.	86
Circuit diagrams.....	77
Cleaning agents.....	64
Cleaning of the rotor chamber.....	65

Cleaning the rotational vacuum concentrator .....	64
Cleaning the RVC and the accessories.....	64
Click at button push .....	56
Closing the lid .....	34
Commissioning .....	9
Condensation of the vapours upstream of the vacuum pump in a cooling trap.....	32
Connection for aeration and air injection with ambient air (state of delivery) .....	27
Connection for aeration and air injection with inert gas .....	27
Connection for aeration with ambient air and air injection with inert gas .....	27
Connection of a vacuum pump and/or a cooling trap.....	30
Connection requirements .....	76
Continuous operation coldtrap .....	56
Continuous operation vacuum pump.....	56
Copying a program .....	52
Copyright .....	9
Corrosion .....	38, 64, 65, 70
Cost estimate.....	74
Cracks .....	70
Creating a new program.....	50
Customer-provided fuses .....	26

### D

Dangerous goods.....	20
Dangerous materials.....	72
Declaration of conformity .....	84
Declaration of conformity – China RoHS 2.	86
Declaration of decontamination.....	74
Deleting a program .....	52
Dimensions .....	23
Dimensions of the rotor chamber .....	76
Dimensions of the unit .....	76
Direct hazard to the life and health.....	16
Disinfection of the rotor chamber and accessories .....	72
Display .....	41
Disposal of the packaging.....	75
Disposal of the RVC.....	75

## Index

<b>E</b>	
Earth conductor check .....	21
EC-Declaration of conformity .....	84
Editing a program.....	51
Electrical connection .....	76
Electrical safety.....	18
EMC according to EN 55011.....	76
Emergency lid release .....	60
Emissions .....	19
Equipment connection .....	77
Equipotential bonding screw .....	21, 26
Error correction .....	58
Error messages .....	21, 58
Evaporation with different tube sizes.....	37
Evaporation with low capacity .....	37
Examples of use .....	14
Explanation of symbols .....	9
Explanation of the symbols and notes.....	16
Extended service menu.....	57
<b>F</b>	
Factory settings loaded.....	59
Fire prevention.....	19
Form for the return of defective parts .....	74
Function keys.....	41
Functional and operating elements .....	10
Fuses.....	19
<b>G</b>	
General conditions .....	8
General malfunctions .....	58
Glass breakage.....	71
Glass tubes.....	72
<b>H</b>	
Hazard warnings .....	8, 34
High temperature resolution.....	56
Highly corrosive substances .....	18
Humidity.....	77
<b>I</b>	
Ice condenser temperature not reached.....	59
Imbalance .....	20, 35
Importance of the operating manual.....	8
Important information .....	16
Infectious substances .....	19
Inflammable substances .....	19
Informal safety instructions .....	17
Information status .....	54
Initial start-up .....	34
Installation direction of the pressure control valve.....	29
Installation of accessories .....	37
Installation of angle rotors .....	35
Installation of rotors and accessories .....	35
Installation of swing-out rotors.....	37
Installation site .....	26
Intended use .....	8
IO communication error.....	60
IP code .....	76
<b>L</b>	
Layout of the RVC.....	10
Lid cannot be opened .....	58
Lid contacts error .....	58
Lid lock device .....	21
Lid status .....	43
Load default settings.....	57
<b>M</b>	
Main menu .....	47
Mains fuse .....	76
Mains input .....	77
Mains power failure.....	59
Mains power switch.....	34
Mains voltage.....	77
Maintenance .....	64
Maintenance and service .....	64
Malfunctions.....	58
Manual evaporation .....	45
Manufacturer.....	19, 20, 64, 75, 76
Marking of the unit .....	15
Mathematical relations .....	78
Max. density of material at process start ....	76
Max. humidity.....	77
Max. lid opening angle .....	76
Max. permissible imbalance.....	76
Maximum current for the vacuum pump ....	30
Mechanical safety .....	18
Micro injection valve.....	77
Mode.....	44
Mode of operation.....	12

**N**

Name plate .....	11, 18
No ice condenser sensor signal .....	58
No rotor chamber sensor signal .....	58
No rotor detected (only Triple TMM).....	59
No rotor sensor signal.....	58
No vacuum sensor signal.....	58
Noise level according to DIN 45635 .....	76
Nominal current .....	76
Nominal rotor speed not reached .....	59
Nominal voltage .....	11, 18
Notes on safety and hazards .....	8

**O**

On-site transport .....	24
Opening the lid.....	34, 44
Operating elements.....	10
Operating mode .....	43
Operating personnel .....	17
Operating voltage.....	26
Option: Pressure control valve and vacuum sensor .....	29
Option: Remote control of the cooling trap via RVC .....	32
Options .....	55
Order number .....	76
Overview of evaporation times (RVC 2-33 CDplus with infrared heating) .....	80

**P**

Packaging .....	23
Packaging, disposal .....	75
Part number .....	11
Pathogenic substances .....	19
Pending information .....	43
Performance data .....	76
Permissible imbalance exceeded.....	59
Physical data .....	76
Pivotal point .....	39
Polycarbonate tubes .....	72
Polypropylene tubes .....	72
Potential hazard to the life and health .....	16
Potentially hazardous situation.....	16
Power cord.....	18
Power failure safety .....	21
Power supply .....	26
Pressure control valve .....	29, 77

Pressure control valve connection .....	76
Pressure increase test .....	53, 88
Pressure marks.....	70
Prevention of accidents.....	8, 17
Principle of the rotational vacuum concentration.....	12
Procedures in the event of hazards and accidents .....	22
Process and equipment information .....	54
Process messages.....	59
Program administration .....	50
Program memory information.....	52
Program-controlled evaporation .....	45
Protection class .....	26, 76
Protection of the environment .....	17

**R**

Radioactive substances .....	19
Rated current .....	11
Relative centrifugal force.....	76
Remaining hazards .....	22
Remote control of the cooling trap via RVC	32
Remove the glass particles and the metal dust from the rotor chamber .....	71
Responsibility of the operator.....	17
Return of defective parts .....	73
Risk of burns.....	44
Rotor blocks.....	39
Rotor chamber, cleaning .....	65
Rotor overtemperature .....	58
Rotor speed .....	56

**S**

Safety area .....	20
Safety class .....	18
Safety data sheets .....	77
Safety devices .....	21
Safety distance .....	18, 20, 26
Safety instructions.....	8, 34
Safety instructions for evaporation .....	20
Safety pressure.....	48, 89
Safety pressure not reached .....	59
Safety-conscious work .....	17
Scope of supply .....	9
Select language .....	55
Serial interface .....	77
Serial number .....	11, 63, 73

## Index

Service.....	73	Thermal stress .....	26, 64
Service contact .....	63	Timer Evaporation.....	48
Service life .....	64, 71	Timer Heating .....	48
Service life of the accessories.....	72	Timer Warm-up.....	55
Service menu.....	56	Toxic substances .....	19
Settings.....	55	Transport safety devices .....	24
Set-up and connection .....	26	Tubes.....	38
Signs of corrosion .....	70	Type.....	11, 76
Small flange connections .....	62	Type of connection.....	26
Solvents.....	64	Type of the RVC .....	73
Special functions.....	53	<b>U</b>	
Specialist personnel.....	73	Units of protection class I .....	26
Speed .....	76	Up and down keys .....	41
Standards and regulations .....	9	User interface .....	41
Status bar .....	42	UV radiation .....	26, 64
Stop valve.....	77	<b>V</b>	
Stop valve connection.....	76	Vacuum .....	48
Stopping the evaporation process		Vacuum connection .....	28, 77
prematurely .....	45	Vacuum pump.....	77
Stopping the warm-up phase prematurely..	45	Vacuum pump connection.....	76
Storage and transport .....	23	Vacuum sensor.....	29, 77
Storage conditions .....	23	Values window .....	42
Stress-corrosion.....	70	Valve block .....	27
Supply voltage .....	26	Vapour pressure curve for ice and water....	12
Surface temperature .....	19, 44	Ventilation.....	26
Susceptibility to corrosion .....	71	Visible damage of the surface.....	70
Switching the RVC on .....	34	VSK3000 calibration error .....	59
System check .....	21	<b>W</b>	
System messages.....	60	Warm-up.....	44
<b>T</b>		Warranty and liability.....	8
Technical data .....	76	Weight .....	23, 76
Technical documentation .....	77	Withdrawal of the vapours by a vacuum	
Teflon tubes.....	72	pump.....	30
Temperature .....	48, 76	<b>Y</b>	
Temperature Warm-up.....	56	Year of manufacture .....	11
Thermal safety .....	19		